



218 ZONE CONTROLLER USER GUIDE



MERIDIAN

Important safety instructions



- Read the instructions.
- Keep these instructions.
- Follow all instructions.
- Do not use this apparatus near water.
- Clean only with a dry cloth.
- Install only in accordance with the manufacturer's instructions.
- Refer all servicing to approved service personnel.

WARNING: TO REDUCE THE RISK OF FIRE OR ELECTRIC SHOCK, DO NOT EXPOSE THIS APPARATUS TO RAIN OR MOISTURE.

This apparatus has been designed with Class 1 construction and must be connected to a mains socket outlet with a protective earthing connection (the third grounding pin).

This apparatus does not include a power switch. The apparatus may be isolated from mains power either by unplugging the power connector from the rear of the unit, or by unplugging the connector at the opposing end of the power cord or cable from its supply outlet. As a result, either or both of these connectors should remain accessible.

Safety warnings

	WARNING! RISK OF ELECTRIC SHOCK – DO NOT OPEN	
ATTENTION! NE PAS OUVRIR – RISQUE DE DÉCHARGE ÉLECTRIQUE		

Caution: to reduce the risk of electric shock, do not remove cover. No user serviceable parts inside. Refer servicing to qualified service personnel.



The lightning flash with arrowhead symbol, within an equilateral triangle, is intended to alert the user to the presence of uninsulated “dangerous voltage” within the product’s enclosure that may be of sufficient magnitude to constitute a risk of electric shock to persons.



The exclamation point within an equilateral triangle is intended to alert the user to the presence of important operating and maintenance (servicing) instructions in the literature accompanying the appliance.

Climate

The equipment has been designed for use in moderate climates and in domestic situations.



Only use at an altitude not exceeding 2000m.

Safety warnings

- Do not expose the unit to dripping or splashing.
- Do not place any object filled with liquid, such as a vase, on the unit.
- Do not place naked flame sources, such as lighted candles, on the unit.

To avoid overheating

- Do not position the product in direct sunlight.
- Do not position the product near heat sources, such as a radiator.
- Do not position the product on a soft surface such as a carpet.
- Leave at least 10cm around the product to ensure sufficient ventilation.

To avoid interference

- Do not position the unit near strong electrical or magnetic radiation, such as near a power amplifier.

Radio interference

FCC Warning: This equipment generates and can radiate radio frequency energy and if not installed and used correctly in accordance with our instructions may cause interference to radio communications or radio and television reception. It has been type-tested and complies with the limits set out in Subpart J, Part 15 of FCC rules for a Class B computing device. These limits are intended to provide reasonable protection against such interference in home installations.



EEC: This product has been designed and type-tested to comply with the limits set out in EN55032:2015 and EN55024:2010 + A1:2015.

Copyright and acknowledgements

Designed and manufactured in the UK

Sales and service in the UK

Meridian Audio Ltd, Latham Road, Huntingdon,
Cambridgeshire, PE29 6YE, England.

Visit us on the Web

www.meridian-audio.com

Copyright © 2021 Meridian Audio Ltd.

Part no: P88496

MHR: this product incorporates copyright protection technology covered by certain patent applications and intellectual property of Meridian Audio Ltd. This technology is provided for the express purpose of securely containing copyright audio within the Meridian System only. Reverse engineering or circumvention of this protection is strictly prohibited.

Manufactured under licence from MQA Limited. The MQA logo is a trade mark of MQA Limited. © MQA Limited 2017.

Boothroyd|Stuart Meridian, Meridian, and Sooloos are registered trademarks of Meridian Audio Ltd.

Roon is a trademark or registered trademark of Roon Labs LLC.

Sonos and all other Sonos slogans are trademarks or registered trademarks of Sonos, Inc.

This guide was produced by:
Human-Computer Interface Ltd, www.interface.co.uk

Product registration

Register your Meridian 218 Zone Controller at:

www.meridian-audio.com

Contents

Introduction	1
Specifications	4
Unpacking	5
Applications	7
Configuring the 218 Zone Controller	16
Controlling the 218 Zone Controller	24
Index	25

Introduction

The Meridian 218 is a compact, networked, Zone Controller designed to integrate Meridian DSP loudspeakers into an automated home audio system.

It has analogue and digital stereo inputs, a Roon audio endpoint, and it supports *Works with Sonos* integration in order to meet the needs of a wide range of connectivity and installation requirements.

Outputs

The 218 Zone Controller provides two Meridian SpeakerLink connectors for simple, straightforward connection to Meridian DSP loudspeakers via standard Cat 5 cable. It also has a pair of unbalanced analogue outputs that can be used to drive a stereo power amplifier and passive loudspeakers. An auxiliary digital output allows you to daisy-chain the output of one zone to the digital input of another.

Inputs

The 218 provides a range of audio input connections to cater for a range of installation requirements. These include a digital (co-ax/RCA) S/PDIF input, an optical (TOSLINK) input, and a Meridian SpeakerLink input, as well as an unbalanced analogue input.

The 218 also provides an Ethernet network socket to connect to a Roon streaming system, or to a Sonos system using *Works with Sonos* integration.

Audio processing

The 218 Zone Controller features high-quality audio processing. The digital inputs accept signals up to 192kHz, and the analogue inputs are converted to digital at 96kHz sampling. High resolution files may also be replayed from a Sonos or Roon system.

Signals are processed with Meridian's exclusive apodising filter that ensures maximum audio quality with outputs at 96kHz/24 bit (digital) or 192kHz/24 bit (analogue).

The 218 Zone Controller will also decode MQA (Master Quality Authenticated) audio streams. It can extract the finest of details from music and deliver the audio for rendering either to its own analogue outputs, or to an attached DSP loudspeaker system. The front panel will indicate MQA as will any attached DSP loudspeaker system that can recognise the stream.

When used with analogue loudspeakers the 218 Zone Controller can be configured to provide tone adjustments as well as balance and volume controls, for use with power amplifiers

2 Meridian 218 Zone Controller *User Guide*

or active analogue speakers. Alternatively it can be configured for fixed output, for connection to an external analogue preamplifier.

When used with Meridian DSP Speakers, the 218 Zone Controller provides control of additional audio processing in the speakers, such as treble and bass tone controls and enhanced room boundary equalisation.

Works with Sonos

Works with Sonos enables users to seamlessly stream music from their Sonos app to their Meridian system while allowing them to control the music anywhere around their home using the Sonos interface. This is done by using the 218 in conjunction with the Sonos Port or Sonos Connect products, using the Sonos S1 or S2 apps.



Roon Tested

Roon's fundamental goal is to provide a consistently stellar user experience. This goal doesn't stop at the software... the experience extends all the way down to the audio playback hardware, regardless of manufacturer.

As a Roon Tested partner, Meridian has provided equipment to Roon for testing with a variety of different operating systems and computers, and shared information about its design and capabilities.



System integration

The 218 Zone Controller is designed to be both configured and controlled via its Ethernet socket.

The 218 can be configured simply by entering the product's IP address into a standard web browser; this then gives access to the range of setup and operational options.

The 218 is controlled using the Automation Protocol, which allows full control of all the runtime settings of the unit, including source selection, volume, and audio menus. This can be integrated into the automation system provided by the installer as well as accessed directly via a tablet or smartphone running the **Meridian Control** application; see *Controlling the 218 Zone Controller*, page 24.

The Trigger output is provided for direct control of external devices, for example enabling a power amplifier.

Ethernet control

The 218 can also be controlled via the Ethernet connection using the Automation Protocol, which allows full control of all runtime settings of the unit including source selection, volume, and audio menus.

Installers can integrate the Automation Protocol into an automation system; for details contact Meridian support.

The Automation Protocol can also be accessed directly via a tablet or smartphone running the **Meridian Control** app; see *Controlling the 218 Zone Controller*, page 24. This is a free application for iOS devices; search for **Meridian** in the Apple App Store or Google Play Store to download it.

Accessories

The following accessories are available for the 218:

- A rack tray for mounting the 218 in a standard 19" rack; see *Installing 218 Zone Controllers in a rack tray*, page 14.
- A mount kit for mounting the 218 under a shelf, on a wall, or in a backbox; see *Mounting a 218 Zone Controller*, page 15.
- A Meridian G12 remote eye to receive infra red signals.
- A Meridian MSR2 or AC200 remote to control the 218 via the G12.

Specifications

Audio outputs

- 2-channel unbalanced analogue output, driven by a 192kHz digital to analogue converter.
- 2-channel digital coax output (RCA).
- Two 2-channel Meridian SpeakerLink outputs.
- Optional MHR encryption on digital outputs.

Audio inputs

- One 2-channel unbalanced analogue input with adjustable sensitivity.
- One 2-channel digital coax input (RCA), 44.1kHz to 192kHz and up to 24-bit precision.
- One 2-channel Meridian SpeakerLink input, 44.1kHz to 192kHz and up to 24-bit precision.
- One 2-channel digital optical (Toslink), 44.1kHz to 96kHz and up to 24-bit precision.
- One network input for connecting to a Sonos or Roon streaming system and IP control systems.

Control signals

- One 12VDC/100mA trigger output configurable by source.
- One IR input, compatible with the Meridian G12 remote IR sensor.

Signal processing

The 218 uses Meridian's proprietary DSP software to provide the following powerful features:

- Apodising filter.
- Upsampling.
- FIFO and error correction.
- Resolution enhancement.
- MQA decoding and rendering.

Indicators

- Front panel indicators for source selection, standby state, and MQA status.
- Rear panel indicator for power.

Physical

- Dimensions: 203mm x 42mm x 159mm (8.0" x 1.65" x 6.3") (W x H x D without feet or connectors).
- Weight: 0.72kg (1.6lb).

Power

- 4W standby; 5W max.
- 100–240V AC, 50–60Hz.

Unpacking

The 218 Zone Controller is supplied with:

- A power cord.
- Four self-adhesive feet.
- Quick Start Guide

Please contact your retailer if the power cord has the wrong plug for your territory.

The feet can be fixed to the base of the product, which is printed with circles as a guide. The feet will not be needed if you are mounting the unit on a rack tray; see *Installing 218 Zone Controllers in a rack tray*, page 14.

Front-panel indicators

The currently selected source is indicated by one of five white indicators on the front panel. In standby the leftmost indicator shows blue.

The rightmost indicator shows the MQA status: magenta (MQA Core), green (MQA) or blue (MQA Studio).

Back panel

The following diagram gives details of the back panel connections:

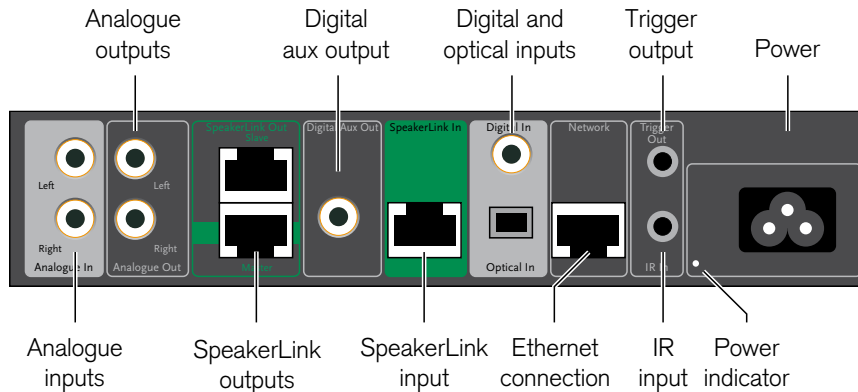

6 Meridian 218 Zone Controller *User Guide*

Audio inputs

Use this input	To connect to this
Analogue in (Radio, Tape)	The analogue outputs of a source, such as a radio or tape deck.
Digital In (CD, USB)	The digital output of a source such as a CD player.
SpeakerLink In (DVD, Disc)	The SpeakerLink output of a Meridian source, using a Meridian SpeakerLink lead.
Optical In (TV, Cable, Sat, PVR, Game)	The optical output of a source such as a satellite receiver.
Network (SLS)	A Sonos or Roon streaming system.

The default source assignments are shown after the input name in the table above.

Communications connections

Use this connection	To connect to this
Trigger Out	Equipment to be enabled by a DC signal, such as a power amplifier.
IR In	A Meridian infra-red eye.

Audio outputs

Use this output	To connect to this
Analogue Out	The unbalanced analogue inputs of a preamplifier, or a power amplifier such as the G57, using analogue phono leads.
Digital Aux Out	The digital input of another 218 or a Distributor 1, using a 75Ω digital cable.
SpeakerLink	DSP Loudspeakers with Meridian SpeakerLink connectors, using SpeakerLink leads. Use the lower socket for the Master speaker (Note the extra green band).

Connecting to a network

Many domestic routers feature processes for handling network traffic which interfere with the operation of Meridian networked audio products. A simple unmanaged network switch should therefore be inserted into the system between the router and the Meridian products, as shown in the following applications, and this will allow the audio system to work as expected.

Applications

Minimal system

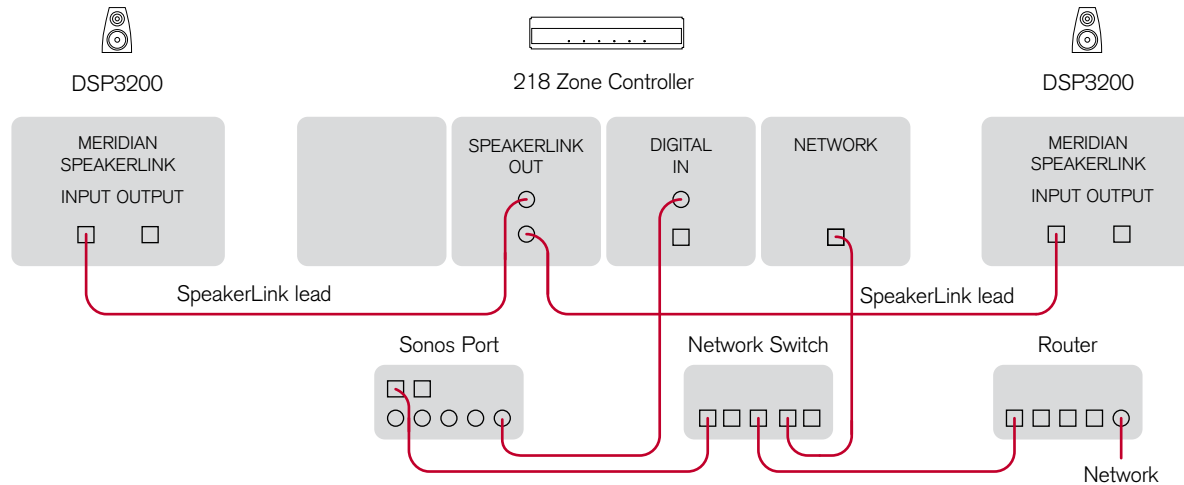

This is a simple, standalone system replaying audio from a Sonos or Roon streaming system.

- Connect the SpeakerLink outputs to the DSP3200s using an RJ45 cables.
- Connect the 218 to the LAN using another RJ45 cable.

- Select the zone in the Sonos or Roon UI and play music in the usual way.

Volume, mute and standby will be controlled from the Sonos or Roon UI. To control other 218 features download the **Meridian Control** app to your mobile device; see *Controlling the 218 Zone Controller*, page 24.

8 Meridian 218 Zone Controller *User Guide*

Audio-visual system

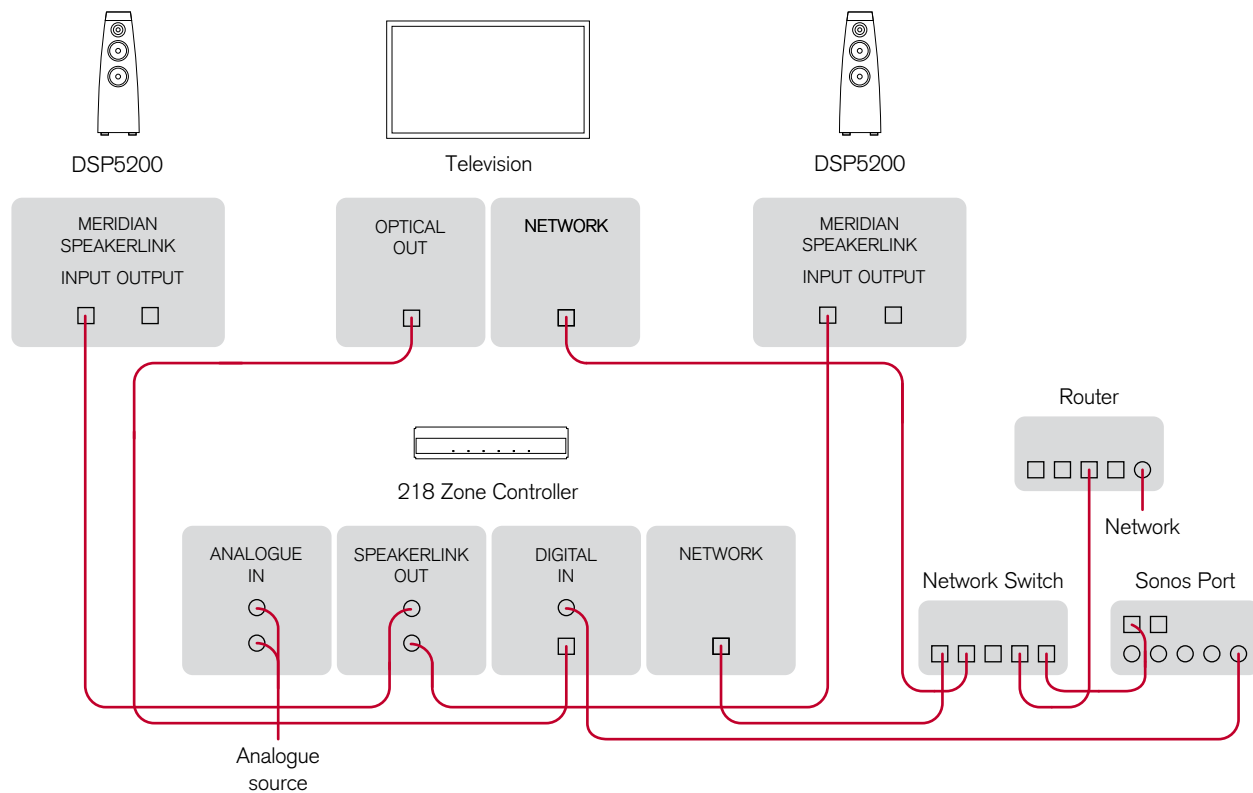

This is a larger system with local sources and more control options.

- Connect the Master SpeakerLink Out socket to the DSP5200 configured as Master using an RJ45 cable.
- Connect the other DSP5200 to the Slave SpeakerLink Out socket.
- Connect the TV to the Optical input socket.
- Connect the 218 to the LAN using an RJ45 cable.
- Optionally connect a Sonos Port or other digital source using a 75 Ω RCA cable.
- Optionally connect an analogue source using 50 Ω RCA cables.

The system can be controlled via the Sonos or Roon UI, the (optional) MSR2, or the Automation Interface using the **Meridian Control** app; see *Controlling the 218 Zone Controller*, page 24 page 24.

10 Meridian 218 Zone Controller *User Guide*

Distributed zone

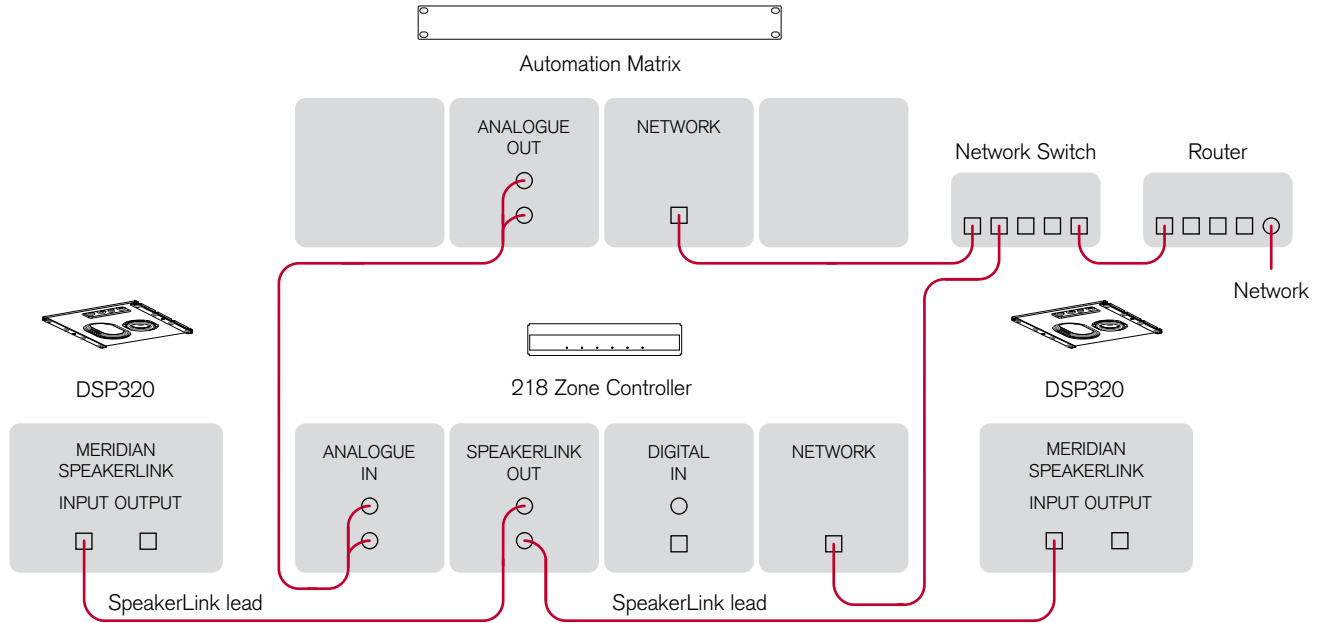

This layout is intended to play back audio in a single zone as part of a larger, whole-house, automation system. The 218 is located in a central rack along with the automation system's audio matrix.

- Connect the Master SpeakerLink output to one of the cables connecting to a DSP320 in-wall loudspeaker.
- Connect the Slave SpeakerLink output to the other DSP320.
- Connect the audio matrix to the 218 analogue input using phono leads.
- Connect the 218 to the LAN using an RJ45 cable.

The system can be controlled using a remote control for the automation system; it will have access to the 218's Automation Interface. The controls that are presented to the user will depend on the UI chosen by the installer.

12 Meridian 218 Zone Controller *User Guide*

Analogue system

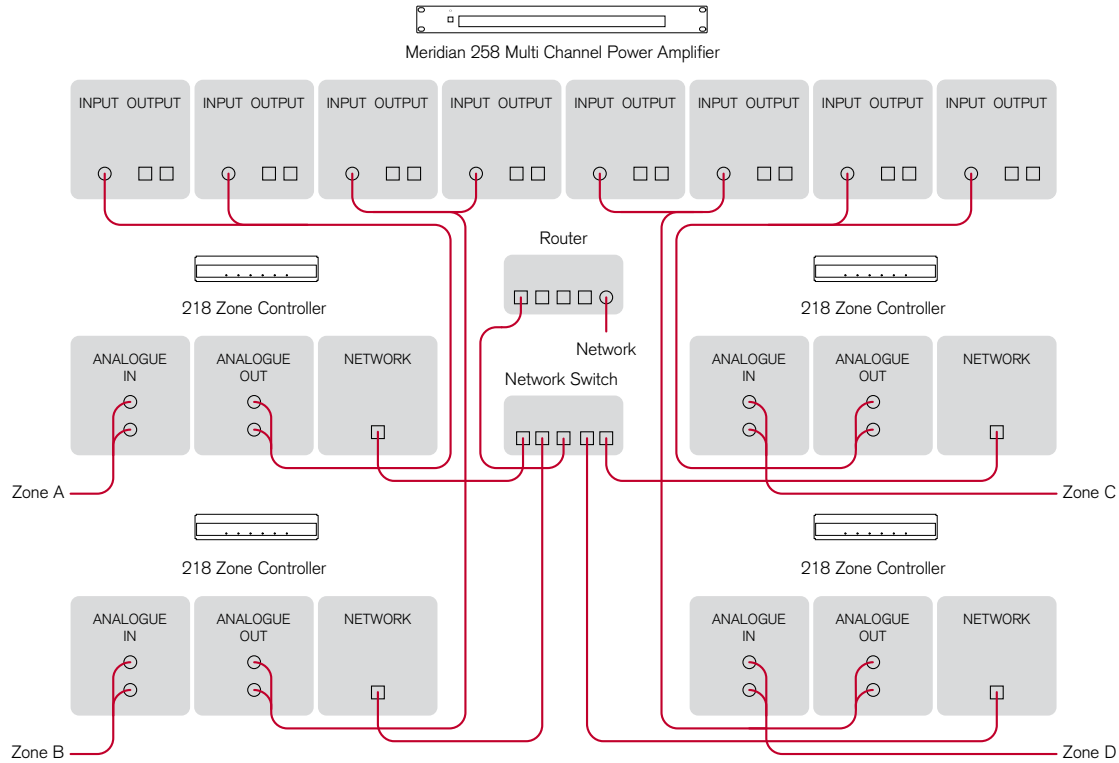

In this system multiple zones are each controlled by a separate 218, using a 258 Multi Channel Power Amplifier to drive the loudspeakers in each zone. The 218s and 258 power amplifier are located in the central rack along with any automation equipment.

- Connect the analogue output of each 218 to a pair of inputs on the 258 using phono leads.
- Connect the speakers in each zone to the 258 using phoenix connectors.
- Connect the 218 to the LAN using an RJ45 cable.

The system can be controlled using a remote control for the automation system; it will have access to each 218's Automation Interface. The controls that are presented to the user will depend on the UI chosen by the installer.

14 Meridian 218 Zone Controller *User Guide*

Installing 218 Zone Controllers in a rack tray

A 218 Rack Tray is available separately, to allow two 218s to be mounted in a standard 19" rack. The Rack Tray is supplied with the screws required to mount the 218.

The MAC address of each 218 is provided on the base of the unit, and we recommend that this is recorded on the tray as it is installed so that it can be identified in future. Adhesive labels are supplied with each Rack Tray for this purpose.

Note that if only one 218 is being installed in a tray then the open side of the fascia can be blanked by one of the knock-outs included in the tray. Remove the knock-out from the tray and bend the two longer tabs to 90 degrees. Affix the two self-adhesive dots and slide the shorter tabs down between the fascia and the tray, resting the longer tabs on the top surface of the tray. Press the knock-out firmly against the back of the fascia to secure.

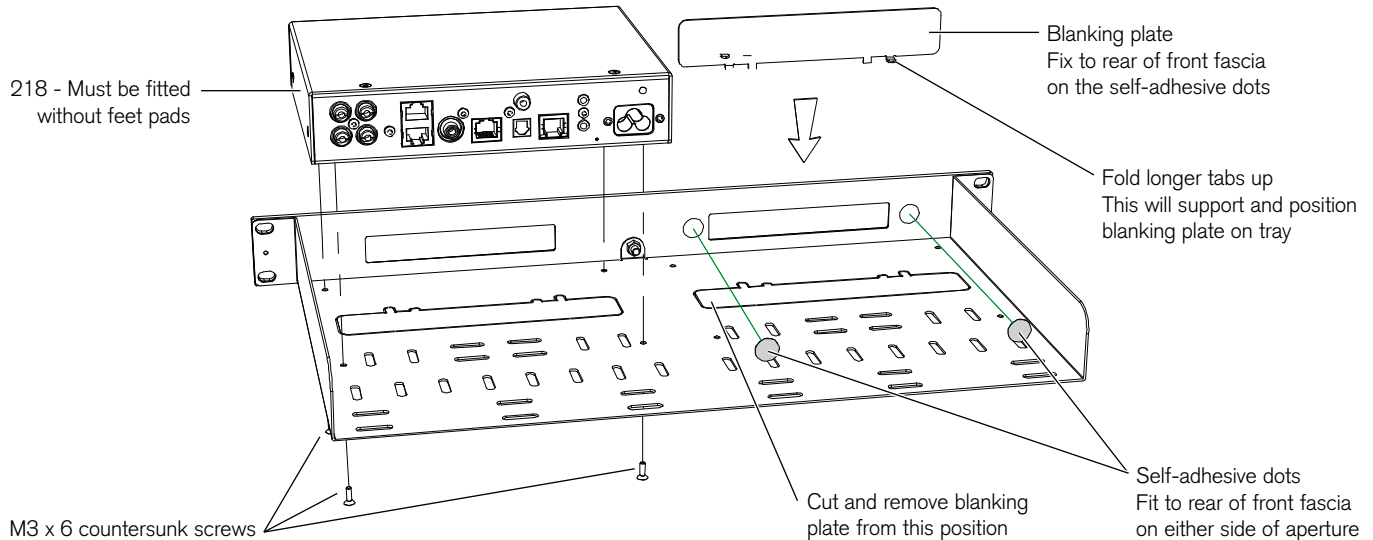

Mounting a 218 Zone Controller

A universal mount kit is available separately, to allow a 218 to be mounted on any flat surface, such as under a shelf, on a wall, or in a backbox.

The kit consists of two plates and four screws, allowing the 218 Zone Controller to be mounted in either of two orientations, as shown in the following diagrams:

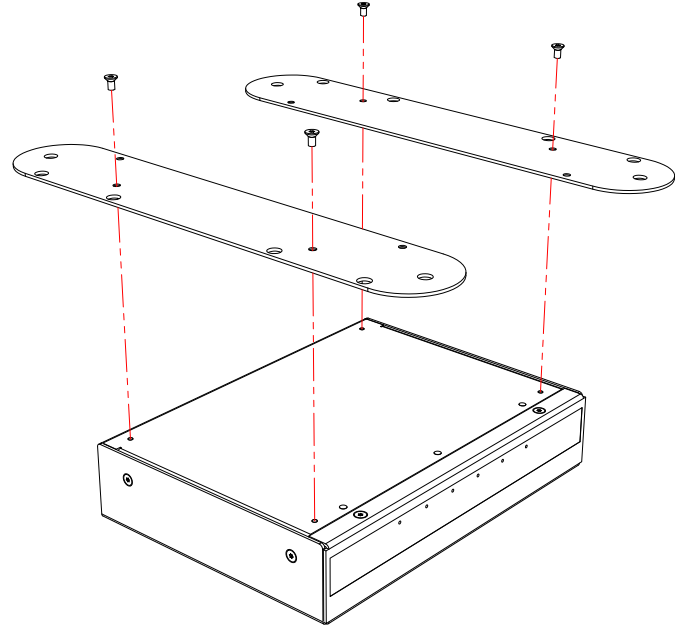
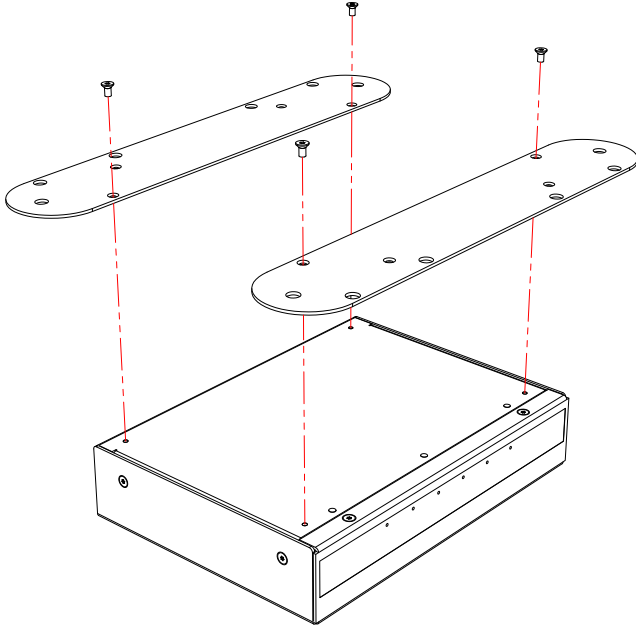

Configuring the 218 Zone Controller

The 218 contains a built-in web interface, allowing it to be configured via the Ethernet connection using a standard web browser.

Displaying the 218 configuration page

To display the 218 configuration page

- Connect the 218 to a network.
- Identify the IP address assigned to the 218 (see below).
- Type this address into the address bar of a standard web browser running on a computer or tablet on the same network.

You should then see the **Meridian 218 configuration** page. This allows you to see or change the 218 settings, or reset them to their defaults, and also gives access to an online version of this user guide.

Full details of each of the groups of settings are given in the following sections.

To store the settings

After changing any settings click the **Store Settings** button below the settings panels.

Restoring settings

- Click the menu button at top left of the **Meridian 218 configuration** page.
- Click **Restore Settings**.

For more information see *Restore Settings*, page 23.

Discovering the IP address of the 218

To discover the IP address of the 218 you can use any of the following methods:

- The **Meridian Control** app (see *Meridian Control app*, page 24) will automatically discover the 218 and link directly to the 218 configuration page.
- Run the **Meridian Device Manager** program on a PC or Mac connected to the same network as the 218.
- Log in to the network router and view the list of attached devices.
- Use a network IP scanner to 'ping' a list of addresses on the network.

Identification

IDENTIFICATION	
Serial number:	000040
Software version:	1.1, build 206
Co-processor version:	0.6.2
Hardware version:	0.8
MAC address:	00-24-c5-00-03-7f
Zone name:	218 #0024c500037f Zone

Identifies the product software version, network MAC address, and Zone name.

Zone name: This identifies the product in the appropriate control interface such as Touch:PC, Control:15, and Control:PC. It is initially set to a unique string, but would normally be set to a meaningful label such as Kitchen or Study.

Audio output

AUDIO OUTPUT	
Analogue output:	<input checked="" type="radio"/> Variable <input type="radio"/> Fixed
Gain offset:	0dB
Digital output:	<input type="radio"/> 1x <input checked="" type="radio"/> 2x
MHR:	<input checked="" type="radio"/> On <input type="radio"/> Off

Analogue output: Choose **Variable** if the 218 is to control the volume of the analogue outputs, or **Fixed** if the analogue outputs are connected to a preamplifier with its own volume control.

Gain offset: Can reduce the level of the analogue output by up to 10dB to match the input of the attached device.

Digital output: For older DSP loudspeakers set to **1x** and **MHR: Off**. For newer 96/24 and SE loudspeakers set to **2x** and **MHR: On**.

18 Meridian 218 Zone Controller *User Guide*

Audio menus

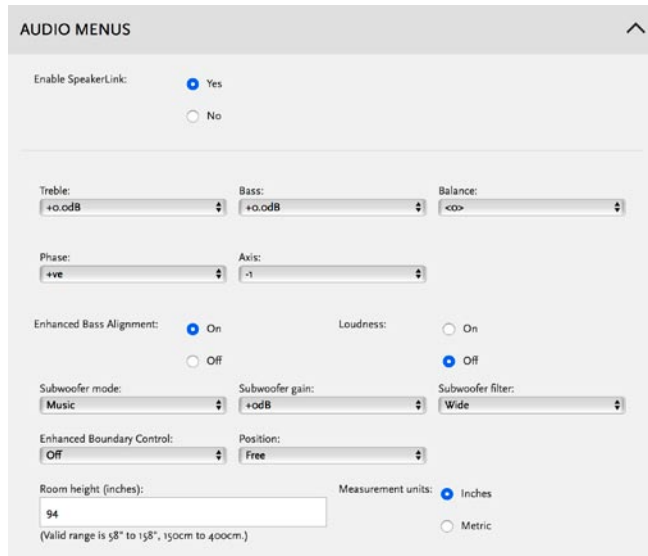

The screenshot shows the 'AUDIO MENU' interface with the following settings:

- Enable SpeakerLink: Yes, No
- Treble: +0.0dB
- Bass: +0.0dB
- Balance: <0>
- Phase: +ve
- Axis: -1
- Enhanced Bass Alignment: On, Off
- Loudness: On, Off
- Subwoofer mode: Music
- Subwoofer gain: +0dB
- Subwoofer filter: Wide
- Enhanced Boundary Control: Off
- Position: Free
- Room height (inches): 94 (Valid range is 58" to 158", 150cm to 400cm.)
- Measurement units: Inches, Metric

The options on the **Audio menu** page allow you to specify the default values of settings on DSP loudspeakers when the 218 is powered up, and change the settings when the loudspeakers are being used.

Enable SpeakerLink: Specifies whether the SpeakerLink controls described on the next page are sent via the SpeakerLink connections.

Treble, Bass, Balance, and Axis

Treble: Tilts the frequency of the response over the entire frequency range to make the sound brighter or dimmer. It can be adjusted between $\pm 10\text{dB}$ in 0.5dB steps.

Bass: Adjusts the bass response in the room by $\pm 5\text{dB}$ in 0.5dB steps.

Balance: Compensates for an off-centre listening position where 0 is central, 8 is in line with the corresponding main speaker, and 10 is fully to one side.

Phase: Changes the absolute phase of the signal, to compensate for signals which are out of phase, giving an unnatural-sounding bass.

Axis: Allows you to compensate for the height of the listener relative to the tweeter. It can be adjusted between -2 and +3, where 0 corresponds to the axis of the tweeter.

Note: **Treble**, **Bass**, and **Balance** are always sent to DSP speakers, but only affect the analogue outputs when the 218 is set up with variable outputs. The **Axis** control only applies to digital outputs.

SpeakerLink controls

These controls only affect DSP loudspeakers connected via SpeakerLink. To use them the **Enable SpeakerLink** option should be set to **On**.

The effect of these options depends on the capabilities of the DSP loudspeakers in the system; see the individual loudspeaker user guide for more information.

Enhanced Bass Alignment: improves the bass alignment in DSP loudspeakers that support it. Note that the extra processing adds a time delay, so it may need to be disabled for video sources.

Loudness: Set to **On** to alter the frequency response to make music sound more natural when played at a low volume setting.

Subwoofer mode: Changes the distribution of bass between the main speakers and the subwoofer to suit **Music** or **Movie** material.

Subwoofer gain: Adjusts the subwoofer gain between +15dB and -15dB.

Subwoofer filter: Adjusts the subwoofer crossover frequency. The options are **Off** (subwoofer off), **Sub1** (80Hz crossover), **Sub2** (120Hz crossover), or **Wide** (subwoofer plays the full range of audio frequencies).

Enhanced Boundary Control: Compensates for reflective room surfaces in DSP loudspeakers that support it, such as the M6 or DSW. Choose between **Off** (unreflective), **Min**, **Med**, or **Max** (highly reflective).

Position: Adjusts the sound to compensate for the placement of the main loudspeakers: **Corner**, **Shelf**, **Wall**, or **Free**.

Room height: Used for **Enhanced Boundary Control** calculations in loudspeakers with downward-firing drive units, such as the M6 or DSW, to compensate for reflections with the room ceiling. Can be varied between 150cm (58in) and 400cm (158in) in steps of 5cm (2in). If the room height exceeds 400cm, select a value which can be multiplied by the lowest possible integer to equal the height. For example, if the height is 500cm, select 250cm ($2 \times 250 = 500$); if the height is 450cm, select 150cm ($3 \times 150 = 450$).

Measurement units: Changes the units used for specifying **Room height**.

Sources

Legend	Audio Input	Sensitivity	Trigger	FIFO	Validity	Lipsync	Comms Type	Address
CD	Digital	+0dB	On	<input checked="" type="checkbox"/>	<input checked="" type="checkbox"/>	oms	1C	1A
Radio	Analogue	2.0V	On	<input checked="" type="checkbox"/>	<input type="checkbox"/>	oms	NC	1A
SLS	Sooloos	n/a	On	<input checked="" type="checkbox"/>	<input checked="" type="checkbox"/>	oms	4C	1A
TV	Optical	+0dB	On	<input checked="" type="checkbox"/>	<input type="checkbox"/>	oms	NC	1A
Tape	Analogue	2.0V	On	<input checked="" type="checkbox"/>	<input type="checkbox"/>	oms	NC	1A
Sat	Optical	+0dB	On	<input checked="" type="checkbox"/>	<input type="checkbox"/>	oms	NC	1A
Disc	SpeakerLink	+0dB	On	<input checked="" type="checkbox"/>	<input type="checkbox"/>	oms	NC	1A
Cable	Optical	+0dB	On	<input checked="" type="checkbox"/>	<input type="checkbox"/>	oms	NC	1A
DVD	SpeakerLink	+0dB	On	<input checked="" type="checkbox"/>	<input type="checkbox"/>	oms	NC	1A
PVR	Optical	+0dB	On	<input checked="" type="checkbox"/>	<input type="checkbox"/>	oms	NC	1A
USB	Digital	+0dB	On	<input checked="" type="checkbox"/>	<input type="checkbox"/>	oms	NC	1A
Game	Optical	+0dB	On	<input checked="" type="checkbox"/>	<input type="checkbox"/>	oms	NC	1A

Allows you to configure the 12 Meridian sources.

Legend: A string of up to 5 characters which will be displayed on the Automation interface and on newer SpeakerLink-enabled DSP loudspeakers.

Audio input: Each of the 12 logical sources can be assigned to any of the audio inputs: **Analogue**, **Digital**, **Optical**, **SpeakerLink**, or **Sooloos**. Alternatively any source can be set to **Last Valid**, which changes the other settings but leaves the input unchanged, **Other** which just makes the source switch on from standby when selected, or **Off**, which makes the source ignore commands.

Sensitivity: For analogue inputs you can select one of five sensitivities: the maximum RMS voltage that can be input before clipping occurs in the ADC. For digital inputs you can select one of five gain values to compensate for loud or quiet digital sources.

Trigger: Can be set to **On**, **Off**, or **LV** (Last Valid) to control the trigger output. Note that the trigger is always off in standby.

FIFO: The FIFO box would normally be checked, but can be unchecked for digital sources with a poor quality clock that the 218 is unable to relock.

Validity: Some sources, such as the Meridian CD players, use the Validity flag in the S/PDIF audio stream to indicate that the audio should not be played. Setting this may reduce unwanted noises in some situations.

Lipsync: Allows you to delay the audio by up to 85msec so that it aligns correctly with a video signal that has been delayed by a scaler. The default is 0ms.

Comms Type: For Comms-connected systems, ensures that the appropriate set of commands is sent to the product. The following categories are available:

1C = CD player, **2C** = Radio, **3C** = DVD player, **4C** = Roon, **5C** = Sonos. All others should be set to **NC** (No Comms).

Address: If there are two or more products of each type then the address should be **1A** for the first, **2A** for the second, etc.

Works with Sonos

The screenshot shows a settings panel titled "WORKS WITH SONOS" with an upward arrow icon. Below the title are two dropdown menus. The first is labeled "Sonos device:" and is set to "None". The second is labeled "Preferred source:" and is set to "TV".

Sonos device: Shows the names and product types of all Sonos products on the network. Select the Sonos device that should send audio to the 218.

The 218 is not itself a Sonos streaming component. It must be used with a Sonos Port or Sonos Connect. Both the Sonos S1 and S2 apps are supported.

Preferred source: Selects the source to be associated with Sonos playback. On the **Sources** panel the same source should be assigned to the audio input on the 218 that is connected to the Sonos device.

Startup

The screenshot shows a settings panel titled "STARTUP" with an upward arrow icon. It contains three settings: "Startup volume:" with a text input field containing "1" and a note "(Valid range is 25 to 87 only, others mean 'last valid')"; "Startup source:" with a dropdown menu set to "SLS"; and "State after power up:" with two radio buttons, "Standby" (selected) and "On".

Startup volume: Specifies the initial volume for the analogue outputs (if variable) and, if the 218 is a Controller, sent on Meridian Comms for other products. The start volume is set when the 218 is first powered up, and a few seconds after going into standby.

By default the 218 starts at volume 65 and retains the last volume setting when it enters and leaves standby.

Startup source: Specifies the source that the 218 will start with if the user has a Source key on their chosen user interface.

State after power up: Set this to **On** to have the 218 playing the startup source when powered up.

22 Meridian 218 Zone Controller *User Guide*

Comms

COMMS

System Address: 1A Product Address: 1A

IR mode: Auto Controller Not Controller

IR receiver is currently: On (Changing to Auto will have no effect until you perform an autosetup.)

System Address: If an installation contains multiple zones that are connected together with Meridian Comms, each one needs a different System Address if they are to have independent source selection and volume controls. If the installation uses LAN connections then this can be left at its default, **1A**.

Product Address: If there are two or more Meridian sources in the same category on the same Comms-connected system then each unit must have a different Product Address. The setting does not apply to IP connected systems and should be left at its default, **1A**.

IR mode: The IR mode is only relevant if a G12 has been connected to the 218. In this setup the installer should set the mode to **Controller** to ensure that the unit functions as the system controller.

IR receiver is currently: Shows the state of the IR receiver.

Ethernet

ETHERNET

Active Ethernet address: 192.168.3.99
Active Ethernet mask: 255.255.255.0
Active Ethernet gateway: 192.168.3.1
Active Ethernet DNS: 192.168.3.1

Connection type: DHCP Static IP

Static Ethernet address: 192 . 168 . 3 . 99
Static Ethernet mask: 255 . 255 . 255 . 0
Static Ethernet gateway: 192 . 168 . 3 . 1
Static Ethernet DNS: 192 . 168 . 3 . 1

Allows you to change the Ethernet configuration. Note that incorrect settings may make the 218 unreachable via the web page.

Restore Settings

RESTORE SETTINGS ^

Select one or more reset buttons and click below to restore a section to factory defaults.
Take extra care with the Ethernet option - your unit may change its IP address and render this page unreachable.

Zone name:

Audio output:

Audio menus:

Source configuration:

Comms and Startup choices:

Ethernet configuration:

Allows you to restore one or more groups of settings to their factory defaults. Note that restoring the Ethernet settings will enable DHCP, which may change the IP address of the 218, and you may have to find the new address as described below.

- Select the checkboxes corresponding to the settings you want to restore.
- Click **Reset Selected** at the bottom of the page.

Zone name: This is used by the Automation Interface to identify the unit. The factory default uses a combination of the product name and MAC address.

Audio output: Returns the analogue and digital outputs to their defaults.

Audio menus: Resets the settings on the **Audio menus** page.

Source configuration: Restores the source legends, their associated audio inputs and Comms configurations; see *Sources*, page 20.

Comms and Startup choices: Returns the startup state to standby and volume to last valid.

Ethernet configuration: Removes any static IP selection and re-enables DHCP. If this box is ticked then the unit will begin the process of getting a new IP address automatically. It may be given a new address by the DHCP server, in which case you will have to find the new address; see *Discovering the IP address of the 218*, page 16.

Controlling the 218 Zone Controller

The Meridian 218 can be controlled using the following options:

- Via Meridian Comms from another product such as a DSP loudspeaker.
- Via the Ethernet connection using the Sooloos system.
- Via the Ethernet connection using the Automation Interface.
- Via Infra Red, using the optional G12 remote IR sensor and either the MSR, MSR+, or AC200 remote controls.

Meridian Control app

Meridian provide a free app for iOS and Android devices called **Meridian Control** that gives access to the source selection and audio controls via the Ethernet connection. Search for **Meridian** in the Apple App Store or Google Play Store to download it.

Ethernet connection

A LAN connection is required to configure the 218 Zone Controller. Also, various aspects of the update and support systems require that the LAN allows Link Local addressing and multicast transmission as well as UDP and TCP traffic (for the music stream and its control). Simple unmanaged switches will always pass this traffic but Wireless Access Points should be selected carefully and managed switches must be configured correctly to pass this traffic.

Third-party IR inputs

The Meridian G12 IR sensor has the following pinout:

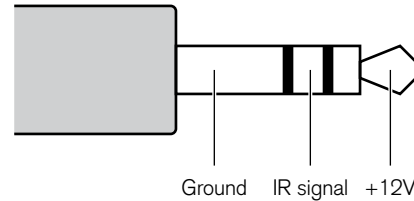

Third-party IR receivers with the same pinout may be compatible but their operation is not guaranteed.

Many home automation/control systems feature outputs suitable for feeding IR emitter devices (also referred to as “IR blasters”). These signals differ from those derived from infra-red receivers in that they are modulated with a carrier frequency. The 218 will automatically detect this and extract the underlying IR signal. Use only the Ring and Sleeve connections for these devices; the Tip (12V) should be left unconnected.

The Automation Interface and IR codes are available to authorised Meridian dealers.

Index

A

- accessories 3
- Address option 21
- Analogue 17
- analogue inputs 6
- analogue outputs 6
- analogue system 12
- applications
 - analogue system 12
 - audio-visual system 8
 - distributed zone 10
 - minimal system 7
- attaching to a VESA mount 15
- audio-visual system 8
- Audio input option 20
- Audio menus panel 18
- Audio output panel 17
- audio processing 1
- Automation Protocol 2

- auxiliary output 5
- Axis option 18

B

- back panel connections 5
- Balance option 18
- Bass option 18

C

- Comms, connecting 6
- Comms panel 22
- Comms Type option 21
- communications connections 6
- configuration 16
- connecting to a network 6
- Control app 24
- controlling 24

D

- digital inputs 6

- Digital option 17
- digital output 6
- distributed zone 10

E

- Enable SpeakerLink option 18
- Enhanced Bass Alignment option 19
- Enhanced Boundary Control option 19
- Ethernet connection 24
- Ethernet control 2
- Ethernet panel 22

F

- FIFO option 20
- front-panel indicators 5

G

- Gain offset option 17

26 Meridian 218 Zone Controller *User Guide*

I

Identification panel 17
indicators 5
inputs 1, 6
installing in a rack tray 14
IP address, discovering 16
IR input 6
IR mode option 22
IR sensor pinout 24

L

Legend option 20
Lipsync option 20
Loudness option 19
loudspeaker outputs 5

M

MAC address 14
Measurement units option 19
Meridian 258 Multi Channel Power
 Amplifier 13

Meridian Control app 24
minimal system 7
MQA status 5

N

network, connecting to 6
network switch 6

O

optical input 6
outputs 1, 6

P

panels
 Audio menus 18
 Audio output 17
 Comms 22
 Ethernet 22
 Identification 17
 Restore Settings 23
 Sources 20

panels (*continued*)
 Startup 21
 Works with Sonos 21
Phase option 18
Position option 19
Preferred source option 21
Product Address option 22

R

rack tray, installing in 14
registration iv
Restore Settings panel 23
restoring settings 16
Room height option 19
Room Tested 2

S

safety warnings iii
Sensitivity option 20
Sonos device option 21
Sonos Port, connecting 9
Sooloos Zone Name option 17

Sources panel 20

SpeakerLink

- inputs 6
- outputs 6

SpeakerLink controls 19

- Room height 19

specifications 4

Startup panel 21

Startup source option 21

Startup volume option 21

Start volume option 21

State after power up option 21

Subwoofer filter option 19

Subwoofer gain option 19

Subwoofer mode option 19

System Address option 22

system integration 2

T

Treble option 18

Trigger option 20

trigger outputs 6

V

Validity option 20

VESA mount, attaching to 15

W

Works with Sonos 2

Works with Sonos panel 21

Z

Zone name option 17