

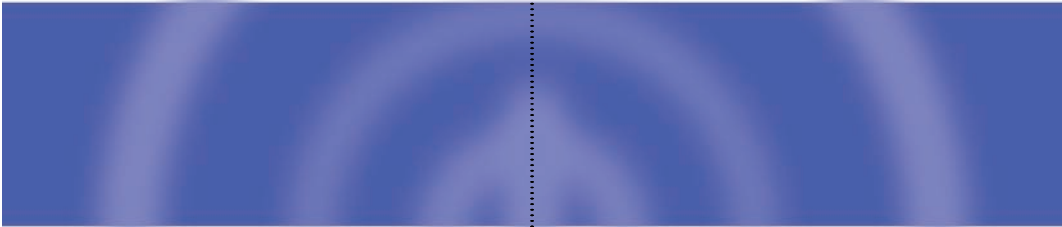

MERIDIAN
SUBWOOFER
USER GUIDE



Meridian Subwoofer User Guide



Important safety instructions

- Read the instructions.
- Keep these instructions.
- Follow all instructions.
- Do not use this apparatus near water.
- Clean only with a dry cloth.
- Install only in accordance with the manufacturer's instructions.
- Refer all servicing to approved service personnel.

Safety warnings

WARNING: TO REDUCE THE RISK OF FIRE OR ELECTRIC SHOCK, DO NOT EXPOSE THIS APPARATUS TO RAIN OR MOISTURE

- Do not expose the speakers to dripping or splashing.
- Do not place any object filled with liquid, such as a vase, on the speakers.
- Do not place naked flame sources, such as lighted candles, on the speakers.

To avoid overheating

- Leave at least 10cm around the equipment to ensure sufficient ventilation.

Do not position the unit:

- In direct sunlight.
- Near heat sources, such as a radiator.
- Directly on top of heat producing equipment, such as a power amplifier.

To avoid interference

Do not position the unit:

- Near strong magnetic radiation.
- Near to a television, or where connecting cables may be subject to or cause interference.

Radio interference

FCC Warning: This equipment generates and can radiate radio frequency energy and if not installed and used correctly in accordance with our instructions may cause interference to radio communications or radio and television reception. It has been type-tested and complies with the limits set out in Subpart J, Part 15 of FCC rules for a Class B computing device. These limits are intended to provide reasonable protection against such interference in home installations.

EU: This product has been designed and type-tested to comply with the limits set out in EN55013 and EN55020.



.....

Contents

.....

Introduction	1
Meridian subwoofers	2
Sample configurations	3
Specification – SW1600	4
Specification – SW5500	6
Available accessories	8
Setting up the subwoofer	9
Unpacking	10
Installing the subwoofer	11
Positioning the subwoofer	14
Connecting the subwoofer	15
Connecting the subwoofer to other equipment	17
Adjusting the subwoofer	20
Troubleshooting	23
Troubleshooting	24
Service and guarantee	25
Index	27

Copyright and acknowledgements

Sales and service in the UK

Meridian Audio Ltd
Latham Road
Huntingdon
Cambridgeshire
PE29 6YE
England

Tel (01480) 445678
Fax (01480) 445686

Sales and service in the USA

Meridian America Inc
8055 Troon Circle
Suite C
Austell
GA30168-7849
USA

Tel (404) 344 7111
Fax (404) 346 7111

World Wide Web – <http://www.meridian-audio.com>

Designed and manufactured in the UK by

Meridian Audio Ltd
Latham Road
Huntingdon
Cambridgeshire
PE29 6YE
England

Copyright © 2005 Meridian Audio Ltd.

Part no: SUBU/1

Boothroyd|Stuart Meridian, Meridian,
Meridian Digital Theatre, Meridian
Lossless Packing, MHR and MLP are
registered trademarks of Meridian
Audio Ltd.

This guide was produced by:
Human-Computer Interface Ltd,
<http://www.interface.co.uk>

MHR: This product incorporates
copyright protection technology covered
by certain patent applications and
intellectual property of Meridian Audio
Ltd. This technology is provided for the
express purpose of securely containing
copyright audio within the Meridian
System only. Reverse engineering or
circumvention of this protection is
strictly prohibited.



Introduction

**Welcome to the Meridian SW1600 and SW5500 subwoofers.
This User Guide provides full information about using the subwoofers
in conjunction with your other equipment, to achieve the superb
results you can expect from them.**



Meridian subwoofers

The Meridian SW1600 and SW5500 combine the finest materials with state of the art design to create what we believe are the ultimate subwoofers, emphasising extreme bass, depth, clarity, control, and articulation.

Each subwoofer provides both digital and active analogue inputs, allowing them to be connected either to a digital surround controller or digital source with a digital coax output, or to an analogue preamplifier or surround controller with either phono or balanced outputs.

Digital Signal Processing

The subwoofers employ 96kHz/24bit digital to analogue conversion and accept digital inputs up to 96kHz including those carrying MHR signals.

Separate analogue and digital power supplies are used to feed the subwoofer's precision electronic circuits, ensuring that both high and low power sections receive continual smooth supply.

If you are using the subwoofers with a digital source, such as CD or DVD, the signals remain in digital form until the last possible stage.

Subwoofer drivers

The subwoofers are based on 300mm (12") high-efficiency long-throw custom drive bass units. The SW1600 uses a single driver, and the SW5500 uses two drivers in a single enclosure. In each case the enclosure is sealed for maximum flexibility of positioning.

Power amplifiers

The speakers are driven by Class G high efficiency ultra low output impedance amplifiers. The combination of idealised magnetic design, careful star earthing, and very fast output devices gives the amplifiers extremely low noise and fast bass, optimised for both music and movie soundtracks.

The whole electronic assembly is supplied from substantial toroidal transformers feeding high-quality, audiophile-grade capacitors.

Cabinet

Each subwoofer is carefully constructed from 22mm MDF with inert basket bracing and resin damping to produce an ultra-rigid cabinet.

The subwoofer is finished with a 6mm annealed glass plate top and thick veneered MDF sides bolted to the main cabinet, giving extremely low levels of cabinet resonance.

Sample configurations

Meridian Digital Theatre™

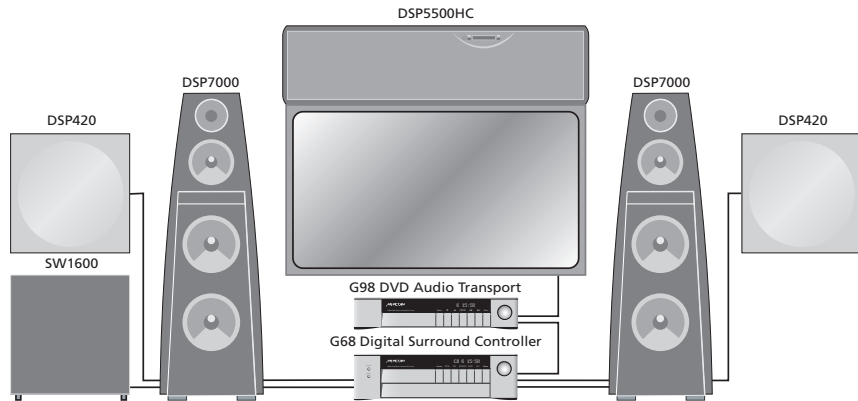

Up to seven Meridian DSP loudspeakers can be used in conjunction with a Meridian Surround Processor, such as the G68 Digital Surround Controller, to create a digital surround system with superb music and cinema sound.

A SW1600 is ideal as a mono subwoofer for the system, to give exciting cinema effects and added realism in DVD movies.

Meridian Digital Music System

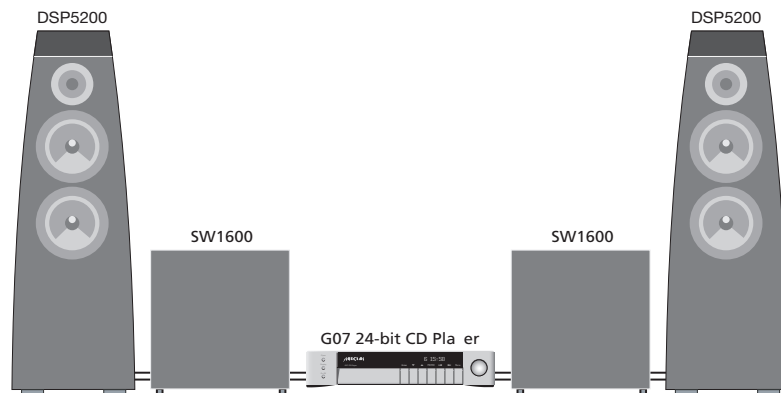

Meridian DSP loudspeakers include DSP volume and tone controls, and can be connected directly to up to two digital sources, such as the G07 24-bit CD Player, to create an extremely compact high-quality music system.

The recommended configuration for music is to provide two subwoofers, one for each of the main left and right channels, for a superb stereo image.

Specification – SW1600



Digital inputs

- 2 x cable inputs, 32-96kHz.
- PCM using IEC958, or MHR connection support with auto-detection.

Analogue inputs

- 3 x phono inputs: mono, left, right.
- 3 x XLR balanced inputs: mono, left, right.

Output stage

- Power amplifier: 150W Class G high efficiency ultra low output impedance.

Acoustic

- Sealed enclosure; no port noise.
- 1 x 300mm (12") high-efficiency long-throw custom driver.
- Inert basket braced resin damped cabinet.

Characteristics

- Distortion <0.01%, typically <0.02% up to full power at all frequencies.
- Noise and hum <-72dBm.
- Acoustic output typically >107dB spl @ 1m.
- Frequency response within 3dB, 20Hz-400Hz (Bypass).

Control

- 2 x Meridian Comms.
- Variable gain control.
- Variable low pass filter 40Hz-150Hz.
- Internal filter defeat switch.
- Absolute phase switch.

Cabinet

- Cabinet constructed from 22mm MDF.
- 6mm annealed plate glass top.
- 416mm x 416mm x 416mm (16.4" x 16.4" x 16.4") (W x H x D excluding feet).
- 28kg (62lb).

Power

- 100/115/120V; 220/230/240V AC 50-60Hz.
- 20-500VA

Meridian Audio reserves the right to amend product specifications at any time.

Specification – SW5500

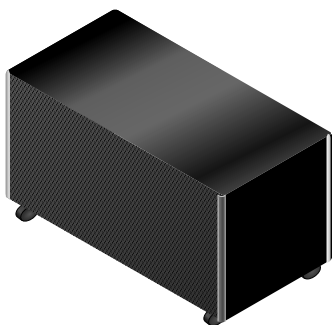

Digital inputs

- 2 x cable inputs, 32-96kHz.
- PCM using IEC958, or MHR connection support with auto-detection.

Analogue inputs

- 3 x phono inputs: mono, left, right.
- 3 x XLR balanced inputs: mono, left, right.

Output stage

- Power amplifier: 300W Class G high efficiency ultra low output impedance.

Acoustic

- Sealed enclosure; no port noise.
- 2 x 300mm (12") high-efficiency long-throw custom drivers.
- Inert basket braced resin damped cabinet.

Characteristics

- Distortion <0.01%, typically <0.02% up to full power at all frequencies.
- Noise and hum <-72dBm.
- Acoustic output typically >110dB spl @ 1m.
- Frequency response within 3dB, 20Hz-400Hz (Bypass).

Control

- 2 x Meridian Comms.
- Variable gain control.
- Variable low pass filter 40Hz-150Hz.
- Internal filter defeat switch.
- Absolute phase switch.

Cabinet

- Cabinet constructed from 22mm MDF.
- 6mm annealed plate glass top.
- 788mm x 416mm x 440mm (31.1" x 16.4" x 17.3") (W x H x D excluding feet).
- 50kg (110lb).

Power

- 100/115/120V; 220/230/240V AC 50-60Hz.
- 20-500VA

Meridian Audio reserves the right to amend product specifications at any time.

Available accessories

Each subwoofer is shipped complete with cables to enable it to be used in a Meridian Digital Music System.

Other applications, and some advanced features, may require one or more of the following accessories, which can be purchased from your Meridian dealer:

- Additional S5 leads (8m and 14m).
- 511 S-patch box if connecting more than two DSP loudspeakers to a G68 Digital Surround Controller (not required with 861).



Setting up the subwoofer

This chapter explains how to install your subwoofer. It describes what you should find when you unpack the subwoofer, how you should connect it to your other audio equipment, and the siting constraints.

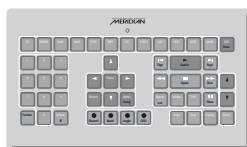

Unpacking

Before you begin installation you should ensure that your subwoofer is the correct voltage for your local AC supply. If it is not, do not try to install it, and contact your dealer.

You should not make any connections to the subwoofer, or to any other component in your system, while the AC power supply is connected and switched on.

Care when unpacking

Take great care when unpacking or repacking the subwoofer that you do not put undue pressure on the front, as it may be damaged if pressed.

Components

The subwoofer comes in a carton with the following components:

- The subwoofer complete with grille.
- Four screw in spikes, locknuts, and washers.
- A nut spanner (wrench).
- Four foot mouldings and hexagonal-head bolts.
- One Meridian analogue phono cable.
- One Meridian slave lead (S-lead).
- One Meridian Slave-Y lead (SY-lead).
- This manual.
- One power cord.

Warning: The subwoofer is extremely heavy. Do not attempt to lift it without assistance.

If any of these items is missing, please contact your dealer. We suggest that you retain the packaging carefully for maximum protection in transit.

Installing the subwoofer

The subwoofer can be mounted using one of four different methods: foot mouldings alone, foot mouldings and spikes, spikes alone, and castors. The mountings are designed to give the subwoofer a stable base on a wide range of surfaces.

To fit the castors

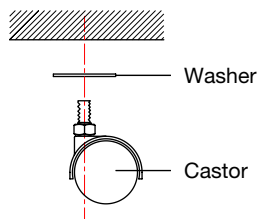

Castors are useful if the unit needs to be installed in a cabinet or other enclosed space and rolled in after connections have been made. However, you may alternatively find that the feet allow sufficient manoeuvrability to do this: the unit will be less likely to move around if the feet are used.

Begin by placing the washer provided on the threaded shaft of the castor. It is important to use the washer as it spreads the off-centre load presented by the castor assembly. Begin to screw the shaft into the threaded insert on the underside of the loudspeaker cabinet until it is engaged a few turns. Once you have started the thread by hand, you will find you can pull the black castor wheel assembly off the shaft (it is a spring fit) to give easy access to the nut with the nut spanner provided. Screw the shaft firmly into the base and then reattach the castor assembly by pushing it firmly onto the shaft. Repeat for the three other castors.

When rolling the subwoofer into position we recommend that you lift the unit over obstacles, such as carpet edges or door thresholds. Rolling the subwoofer over obstacles may exert excessive sideways force on the castors, causing the threaded inserts to be ripped out and damaging the cabinet.

To fit the spikes alone

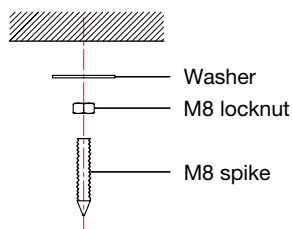

The spikes are designed for use on carpeted floors, where they penetrate the pile without damaging or flattening the carpet. You can use them on their own, or with the plastic foot mouldings provided.

To install the spikes on their own, spin the M8 locking nut provided on to the spike and place the washer provided on top of it. If you are using the spikes on their own it is important to use the washer between the underside of the cabinet and the nut to spread the load on the cabinet.

Screw the spike into the underside of the cabinet and repeat for the other three spikes, screwing them in approximately the right distance. Do not tighten the locknuts at this stage. Stand the subwoofer on the spikes and adjust the latter for a stable, even footing. Then use the nut spanner provided to tighten the locknuts against the washer on the underside of the cabinet.

To fit the spikes with foot mouldings

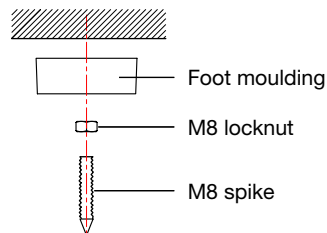

Alternatively you can mount the spikes through the plastic foot mouldings provided. In this case, the washer is not necessary. Insert the spike with its locknut into the underside of the foot moulding so that the locknut engages in the hexagonal cutout in the base of the foot moulding.

Screw the spike into the underside of the cabinet and repeat for the other three spikes, screwing them in approximately the right distance. Do not tighten the locknuts at this stage. Stand the subwoofer on the spikes and adjust them for a stable, even footing. Then use the foot moulding as a wrench to tighten the foot moulding and its associated locknut firmly against the underside of the cabinet.

Note that you cannot screw the spikes far enough up inside the foot moulding so that they do not touch the floor. If you do not need the spikes, use the feet alone.

To fit the foot mouldings alone

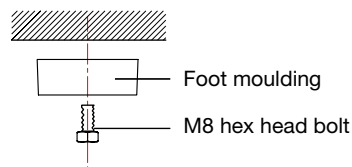

The foot mouldings are designed for use on solid floors where they support the loudspeaker without damaging the surface under the unit. Insert the M8 bolt provided through the foot moulding so that the head engages in

the hexagonal cutout in the underside of the moulding. Screw the bolt into the base of the loudspeaker using the moulding as a wrench, until the foot moulding is flush and firm against the cabinet and is not loose.

To tighten the drive units

The subwoofers typically take about two weeks of normal use for the drive units to settle. It is therefore recommended that you tighten the mounting bolts on each drive unit every few days during this period. Tighten the bolts in symmetrically opposite pairs using the nut spanner provided.

You should then check and if necessary retighten the drive units every few years.

Removing the grille

The grille is guided into position on plugs. To remove the grille pull it gently, starting from the bottom edge. Then pull it evenly away from the sides until it is free. Replace the grille after tightening the drive units.

Positioning the subwoofer

Although it is difficult to localise very low frequency sounds, to get the best from your system it is important to position your subwoofer carefully. You will probably want to place the subwoofer where it is not too obtrusive, but if possible follow these guidelines.

Position relative to other speakers

If there is a single subwoofer in your system, a recommended way of positioning it is to connect it in a temporary location, and go around the room listening for where the bass sounds most natural. Then position the subwoofer in that location. If you have additional subwoofers you can repeat this for the remaining subwoofers.

If the subwoofer is handling the bass for specific speakers in the system, position it as close as possible to those speakers. This will give a more impressive bass effect. For example if you have stereo subwoofers, which are recommended for music reproduction, place them near to the left and right speakers. This will ensure that the bass blends optimally between the main speakers and the subwoofers, giving a good stereo image.

If you have a single mono or centre subwoofer, place it close to the centre of the room at the front, ideally under the centre channel if you have one.

Face the front of the subwoofer towards the listening position. With movies this makes effects more convincing. Do not place anything in front of the subwoofer which could obstruct the air movement from the drive units.

Mechanical interference

Subwoofers produce very high levels of bass, which may cause objects in a room to rattle, and create boomy standing-wave resonances due to the shape of the room. You can minimise these problems by positioning the speakers carefully. If you have a Meridian Digital Surround Processor or a test disc, use the sinewave sweep test to locate resonances and eliminate them.

General recommendations

If possible you should locate the subwoofer so that the electronics on the back of the speaker are not subjected to long term strong sunshine. The rear panel should be cool when the unit is not in use.

Connecting the subwoofer

Back panel

The following diagram gives details of the back panel connections:

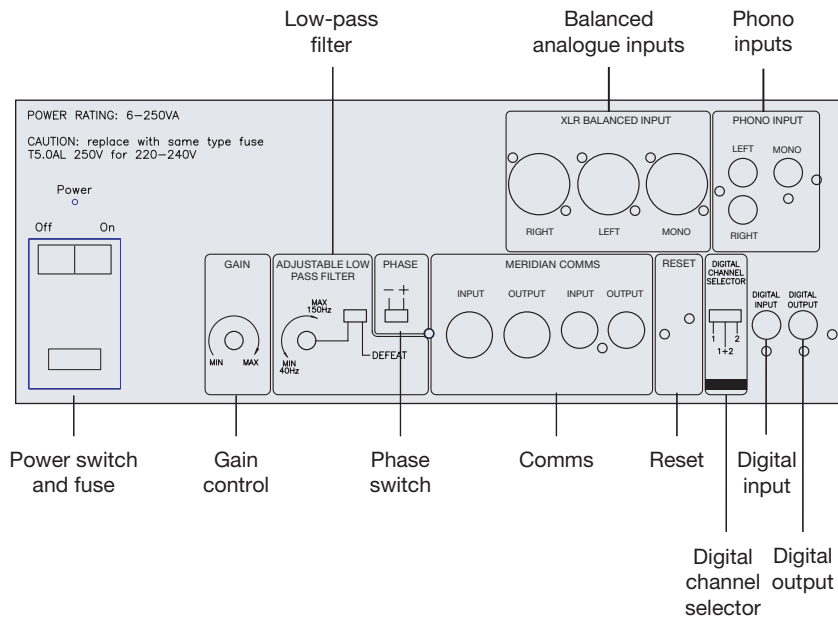

Digital connections

The following table gives details of the digital audio connections:

Use this connection	To connect to this
DIGITAL INPUT	A digital source, such as a digital sound processor, or digital preamplifier.
DIGITAL OUTPUT	A second (slave) DSP loudspeaker, using an S5 lead.

The S/PDIF cable connected to the digital input carries two channels, so you need to set the DIGITAL CHANNEL SELECTOR switch to indicate which channel(s) are directed to the subwoofer.

If you are connecting the subwoofer to the Centre/Sub or Side/Sub output of a Meridian digital surround processor, set the switch to position 2.

If your system includes a stereo pair of subwoofers, set the left subwoofer to position 1 and the right subwoofer to position 2.

If you are connecting a single subwoofer to a stereo digital system with no centre channel output, such as a Meridian CD player, set the switch to position 1+2, to mix the signals from both channels.

The digital connections should be made with high-quality 75Ω screened cable. Suitable cables are available from Meridian. We do not recommend using analogue audio cables, which do not have adequate shielding or the correct impedance, or cables intended for UHF applications, as these do not provide adequate shielding in the 1–30MHz region.

Analogue connections

The following table gives details of the analogue audio connections:

Use this connection	To connect to this
PHONO INPUT MONO	The dedicated subwoofer output of a preamplifier or digital surround controller, if it is the only subwoofer in the system, or the left or right output of a preamplifier or digital surround processor, if the subwoofer is used as one of a stereo pair.
PHONO INPUT LEFT/ RIGHT	The left and right outputs of a preamplifier or digital surround processor, if it is the only subwoofer.
XLR BALANCED INPUT MONO	The dedicated balanced subwoofer output of a preamplifier or digital surround controller, if it is the only subwoofer in the system, or the left or right XLR output of a preamplifier or digital surround processor with balanced outputs, if the subwoofer is one of a stereo pair.
XLR BALANCED INPUT LEFT/RIGHT	The left and right XLR outputs of a preamplifier or digital surround processor with balanced outputs, if it is the only subwoofer.

If you are connecting a single subwoofer to a preamplifier or surround processor with a dedicated subwoofer output, connect this to the appropriate mono input on the subwoofer. Otherwise connect the left and right outputs to the subwoofer left/right inputs, and the subwoofer will mix the channels.

If you are connecting two subwoofers to a system, connect the left channel output to the mono input of the left subwoofer and the right channel output to the mono input of the right subwoofer.

The audio connections should be made with high quality audio phono leads or XLR leads.

Communications connections

The following table gives details of the communications connections:

Use this connection	To connect to this
MERIDIAN COMMS	The COMMS connection on a Meridian control unit or preamplifier, using a COMMS lead

Connecting the subwoofer to other equipment

To connect a subwoofer in a Meridian digital surround system

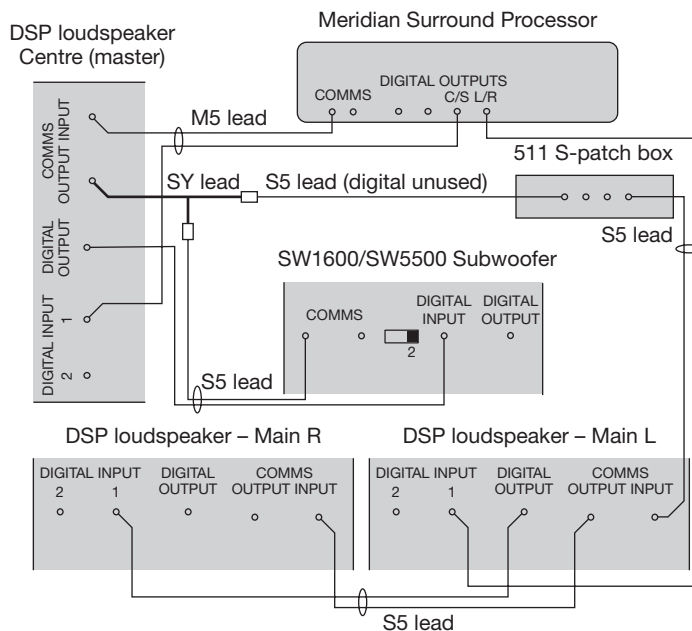

If your system includes more than two Meridian DSP loudspeakers you will need a 511 S-patch box (available separately) to link together the S5 leads from each speaker, as shown above. **Note:** This does not apply to the 861, which includes a built-in patch box.

- Use the comms part of an M5 lead to connect one of the COMMS sockets on the Meridian Surround Processor to the DSP loudspeaker you have chosen as the master (typically the centre speaker).
- Use the audio part of the M5 lead to connect the DSP loudspeaker to the C/S digital output on the Meridian Surround Processor.
- Connect an SY-lead to the COMMS output from the master DSP loudspeaker, then connect one of the sockets on the SY lead to one socket on the 511 using an S5 lead.
- Link all the other DSP loudspeakers together in pairs using S5 leads, as shown in the illustration.

- Connect each pair of DSP loudspeakers to the appropriate digital output on the Meridian Surround Processor, using an S5 lead. The other part of the S5 lead is used to distribute the COMMS from the 511 to each pair of DSP loudspeakers.
- Set the digital channel selection switch to position 2 on the subwoofer.

To connect a subwoofer to a stereo digital source, such as a Meridian CD Player

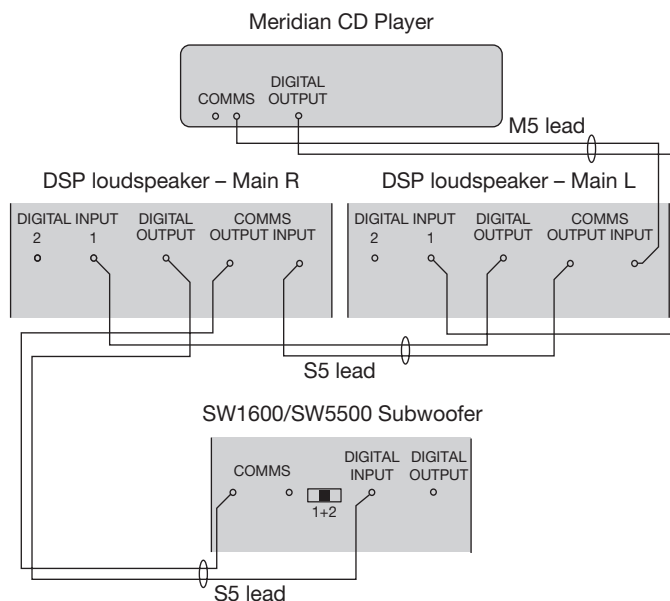

You can connect a pair of DSP loudspeakers and a subwoofer directly to a digital source. The DSP loudspeakers include volume, balance, and tone controls allowing you to control the system using the MSR+.

- Connect the DIGITAL OUTPUT and a COMMS socket from the Meridian source or control unit to DIGITAL INPUT 1 and the COMMS input on the DSP loudspeaker chosen as the master, using an M5 lead.
- Connect the DIGITAL and COMMS outputs from the master DSP loudspeaker to DIGITAL INPUT 1 and the COMMS input on the other (slave) DSP loudspeaker, using an S5 lead.
- Connect the DIGITAL and COMMS outputs from the slave DSP loudspeaker to the DIGITAL INPUT and COMMS on the subwoofer, using an S5 lead.
- Set the digital channel selector switch to position 1+2, to mix the left and right channels to the subwoofer.

To connect a subwoofer to an analogue preamplifier

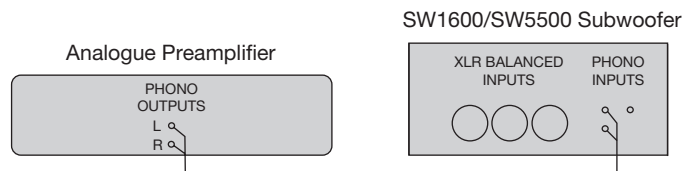

- Connect the analogue outputs from the preamplifier or analogue surround processor to the LEFT and RIGHT phono inputs of the subwoofer.

The subwoofer mixes the channels to create a mono signal.

If your preamplifier provides balanced outputs, use the LEFT and RIGHT XLR BALANCED inputs on the subwoofer instead.

To connect a stereo pair of subwoofers to an analogue preamplifier

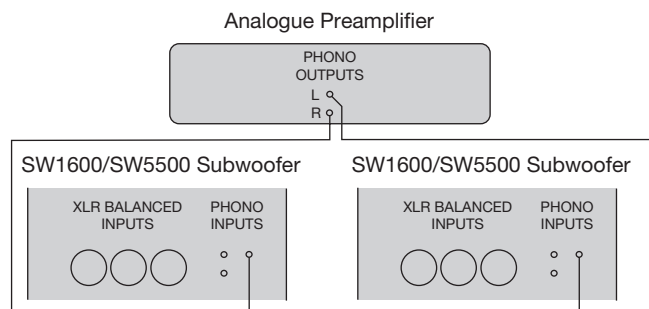

- Connect the left analogue output from the preamplifier to the MONO PHONO INPUT of the left subwoofer.
- Connect the right analogue output from the preamplifier to the MONO PHONO INPUT of the right subwoofer.

If your preamplifier provides balanced outputs, use the MONO XLR BALANCED input on each subwoofer instead.

Adjusting the subwoofer

To set the adjustable low-pass filter

The subwoofer includes a low-pass filter which can be adjusted between 40Hz and 150Hz, or disabled using the DEFEAT switch.

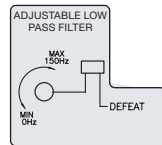

If you are connecting the subwoofer to a digital surround processor that provides its own crossover, such as a Meridian digital surround processor, set the low-pass filter switch to DEFEAT.

If you are connecting the subwoofer to an analogue preamplifier or surround processor, set the low-pass filter to the middle of its range, and then listen to a sweep tone from the processor if it provides one, or alternatively from a test disc, and make sure the bass is smooth throughout the range.

If there is a peak in the bass loudness, the subwoofer may be adding to the bass from your main speakers, in which case reduce the low-pass filter frequency.

Likewise, if there is a dip in the bass loudness, increase the low-pass filter frequency.

To set the gain

The GAIN control allows you to adjust the loudness of the subwoofer to suit the other components in your system.

For the best signal to noise ratio, adjust the level of the subwoofer using the level control on the subwoofer. If you are using a Meridian Digital Surround Processor, you can then use the processor's calibration option to fine-tune the subwoofer level if necessary.

If your surround processor or preamplifier does not include a Calibration option, listen to familiar source materials and adjust the gain until the bass sounds solid and deep, but not boomy or intrusive.



To set the phase

The PHASE switch allows you to invert the phase of the signal to the subwoofer.

If your digital surround processor includes a Calibration option you can adjust the phase in the surround processor, in which case set the switch to the + position.

If the bass sounds hollow or phasey, and does not image correctly, change the position of the PHASE switch. If in doubt, select the position that gives the most bass.



.....

.....



.....

Troubleshooting

.....

This chapter provides suggested solutions to typical problems that may occur when setting up the subwoofer.

If you are still not able to resolve a difficulty with the help of this guide and the suggestions in the following pages, please contact your Meridian dealer or Meridian Audio Ltd.



Troubleshooting

Unit goes silent when played hard

The subwoofer has a temperature sensing system on board, which prevents overheating of the electronics. The sound will continue when the speaker has cooled.

There is radio interference

The subwoofer is a digital audio and computing device which has been designed to very high standards of electromagnetic compatibility.

If this equipment does cause or suffer from interference to/from radio or television reception then the following measures should be tried:

- Reorient the receiving aerial (or antenna) or route the antenna cable of the receiver as far as possible from the subwoofer and its cabling.
- Ensure that the receiver uses well-screened antenna cable.
- Relocate the receiver with respect to the subwoofer.
- Connect the receiver and this product to different AC outlets.
- If the problem persists contact your dealer.

Drive units move when the speaker is switched on or off

This is normal as the speaker active electronics settle.

Subwoofer stays in standby

This indicates a problem with the Comms setup:

- Check the comms cabling; see *Connecting the subwoofer to other equipment*, page 17.
- Reselect the source and increase or decrease the volume.

Subwoofer output sounds odd and lacking in bass when connected to a Meridian digital processor

A digital audio connection carries two channels. Make sure that you are picking up the right one. For example, if you have connected the subwoofer to the Centre/Sub output of the processor, make sure that the digital input switch is set to 2 to pick up the sub signal. If it is set to 1 you will hear the signal intended for the centre channel.

If the speaker on a channel is configured as Small its signal will not contain any bass, and a subwoofer set to pick up that channel will therefore not output much of a signal. Check the subwoofer definitions in the configuration and change as necessary.

Service and guarantee

Service

The Meridian components have been carefully designed to give years of untroubled service. There are no user-serviceable parts inside the case, nor do the units require any form of maintenance.

In the unlikely event that your subwoofer fails to function correctly, it should be returned, in its original packaging, to your Meridian dealer.

In case of difficulty within the UK or USA please contact the appropriate sales and service address shown on page iv.

In case of difficulty outside the UK or USA, contact the importing agent for the territory. A list of Meridian agents abroad is available from Meridian Audio.

No responsibility can be accepted for the subwoofer whilst in transit to the factory or an agent, and customers are therefore advised to insure the unit. When seeking service under guarantee, proof of the date of purchase will be required.

Guarantee

Each subwoofer is guaranteed against defects in material and workmanship for two years from the date of purchase.

The guarantee is void if the subwoofer has been subject to misuse, accident, or negligence, or has been tampered with or modified in any way without the written authorisation of Meridian Audio Limited.

Note: Connecting anything other than the correct network lead to the COMMS sockets may cause damage to the subwoofer which will not be covered by this guarantee. Attempted servicing by unauthorised people may also invalidate this guarantee. Labour and carriage charges are not covered unless by local agreement.

Outside the UK, local warranty liability is restricted to equipment purchased within the territory. Our agents abroad are only under contractual obligation to service under guarantee equipment sold through them. They are entitled to make a non-refundable charge for any service carried out on other equipment.

This guarantee does not limit your statutory rights within the United Kingdom.

.....

.....

.....

Index

A

accessories	8
analogue connections	16

B

balanced inputs	16
------------------------	-----------

C

cabinet	2
castors, fitting	11
COMMS connections	16
communications connections	16
components	10
connecting to other equipment	17
connections	
analogue	16
COMMS	16
communications	16
digital	15

D

digital connections	15
drive units	2, 13

F

foot mouldings, fitting	12
--------------------------------	-----------

G

gain, setting	20
guarantee	25

L

low-pass filter, setting	20
---------------------------------	-----------

M

Meridian Digital Music System	3
Meridian Digital Theatre™	3

P

phase, setting	21
positioning	14
power amplifiers	2

S

safety warnings	ii
sample configurations	
Meridian Digital Music System	3
Meridian Digital Theatre™	3
service	25
specification	
SW1600	4
SW5500	6
spikes, fitting	11
with feet	12
SW1600	4
SW5500	6

T

tightening the drive units	13
troubleshooting	23

U

unpacking	10
------------------	-----------

