

861 Reference Digital Surround Controller User Guide

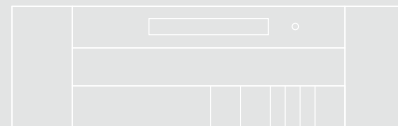

Important safety instructions

- Read the instructions.
- Keep these instructions.
- Follow all instructions.
- Do not use this apparatus near water.
- Clean only with a dry cloth.
- Install only in accordance with the manufacturer's instructions.
- Refer all servicing to approved service personnel.

WARNING: TO REDUCE THE RISK OF FIRE OR ELECTRIC SHOCK, DO NOT EXPOSE THIS APPARATUS TO RAIN OR MOISTURE.

This apparatus has been designed with Class 1 construction and must be connected to a mains socket outlet with a protective earthing connection (the third grounding pin).

This apparatus uses a single-pole power switch. As a result it is not isolated from AC mains power when switched off at the rear panel. The apparatus may be isolated from mains power either by unplugging the power connector from the rear of the unit, or by unplugging the connector at the opposing end of the power cord or cable from its supply outlet. As a result, either or both of these connectors should remain accessible

Safety warnings

- Do not expose the unit to dripping or splashing.
- Do not place any object filled with liquid, such as a vase, on the unit.
- Do not place naked flame sources, such as lighted candles, on the unit.

To avoid overheating

- Leave at least 10cm around the equipment to ensure sufficient ventilation.

Do not position the unit:

- In direct sunlight.
- Near heat sources, such as a radiator.
- Directly on top of heat producing equipment, such as a power amplifier.

To avoid interference

Do not position the unit:

- Near strong electrical or magnetic radiation, such as near a power amplifier.

Radio interference

FCC Warning: This equipment generates and can radiate radio frequency energy and if not installed and used correctly in accordance with our instructions may cause interference to radio communications or radio and television reception. It has been type-tested and complies with the limits set out in Subpart J, Part 15 of FCC rules for a Class B computing device. These limits are intended to provide reasonable protection against such interference in home installations.

EEC: This product has been designed and type-tested to comply with the limits set out in EN55013 and EN55020.



Contents

Introduction	1	Changing the spaciousness of the sound	22
The 861 Reference Digital Surround Controller	2	Changing the LipSync	23
DSP presets and layouts	4	Changing the DSP preset for a source	24
Specifications	6	Defining your own presets	25
Using the 861 Reference Digital Surround Controller	7	DSP presets	27
Front panel keys	8	DSP presets for two-channel material	28
MSR+ keys	9	DSP presets for multichannel material	32
Switching on and off	10	Installing the 861 Reference Digital Surround Controller	35
Selecting a source	11	Unpacking	36
Adjusting the volume	12	Applications	39
Changing the DSP preset	13	Configuring the 861 Reference Digital Surround Controller	45
Changing the display	14	Choosing a standard setting	46
Customising the 861 Reference Digital Surround Controller	15	Calibrating the system	48
Locking and unlocking the menus	16	Calibration tests	49
Changing the DSP parameters	17	Setting up sources	51
Changing treble, bass, or phase	19	Sinewave sweep test	53
Changing the listening position	20	Index	55
Changing the integration of the centre	21		

Copyright and acknowledgements

Sales and service in the UK

Meridian Audio Ltd
Latham Road
Huntingdon
Cambridgeshire
PE29 6YE
England

Tel (01480) 445678
Fax (01480) 445686

Sales and service in the USA

Meridian America Inc
8055 Troon Circle
Suite C
Austell
GA30168-7849
USA

Tel (404) 344 7111
Fax (404) 346 7111

Designed and manufactured in the UK

Meridian Audio Ltd
Latham Road
Huntingdon
Cambridgeshire
PE29 6YE
England

Copyright © 1999-2010 Meridian Audio Ltd.

Visit us on the Web:
<http://www.meridian-audio.com>

Part no: 861U/8 (P85625)

Manufactured under license from Dolby Laboratories Licensing Corporation (Canadian patent 1,037,877), Lucasfilm Ltd. (US patents 5,043,970; 5,189,703; 5,222,059. European patent 0323830), Trifield Productions Ltd, and Nimbus Records Ltd.

MHR: this product incorporates copyright protection technology covered by certain patent applications and intellectual property of Meridian Audio Ltd. This technology is provided for the express purpose of securely containing copyright audio within the Meridian System only. Reverse engineering or circumvention of this protection is strictly prohibited.

Dolby, Dolby Digital, Pro Logic, AC-3, PLII, and the double-D symbol are trademarks of Dolby Laboratories Licensing Corporation. Lucasfilm, THX, and THX Cinema are registered trademarks of Lucasfilm Ltd. Surround EX is a jointly developed technology of THX and Dolby Laboratories, Inc. and is a trademark of Dolby Laboratories, Inc. All rights reserved. Used under authorisation. DTS is a registered trademark of Digital Theatre Systems Inc. MPEG is a registered trademark of the MPEG organisation. Ambisonic is a registered trademark of Nimbus Records Ltd. Trifield is a trademark of Trifield Productions Ltd. LaserDisc is a trademark of Pioneer Electric Corp.

Boothroyd/Stuart Meridian, Meridian, Meridian Digital Theatre, MHR, MLP, LipSync, and Sooloos are registered trademarks of Meridian Audio Ltd.

This guide was produced by:
Human-Computer Interface Ltd,
<http://www.interface.co.uk>

Introduction

Welcome to the Meridian 861 Reference Digital Surround Controller.

This User Guide provides full information about using the surround controller in conjunction with your other equipment, to achieve the superb results you can expect from it.

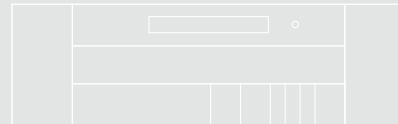

The 861 Reference Digital Surround Controller

Digital signal processing, or DSP, is a technique pioneered by Meridian in hi-fi products for achieving extremely accurate reproduction of audio signals. Unlike conventional analogue systems – which process signals using electronic circuits based on resistors, capacitors, and inductors – DSP works by performing exact mathematical calculations on digital versions of the signals.

The advantage of DSP over analogue circuitry is that the signals are held as precise numbers, rather than voltages in a circuit. This means that any number of stages of processing can be performed with high precision, and without any of the cumulative noise or degradation that inevitably occurs, even with high-quality analogue circuitry. In addition, several of the surround-sound decoding techniques and signal improvement techniques available in the 861 would be virtually impossible to implement in analogue circuitry.

At Meridian we have taken advantage of the availability of high speed DSP microprocessors to incorporate DSP in hi-fi products, and the 861 is the result of over a decade of our research and development in this field.

The 861 takes advantage of DSP for several different functions:

- To de-jitter incoming digital signals and expand the precision of the signal.
- To perform filtering or adjustment of the frequency response; eg treble or bass.
- To decode digitally-encoded signals from Dolby Digital (AC-3), DTS, or MPEG Audio.
- To process the audio into a multichannel signal, and match the source channels to the configuration of main loudspeakers and subwoofers in the system.

The 861 converts analogue input signals to digital format, using high-quality analogue-to-digital converters (ADCs). Digital signals, from CD, DVD, or digital broadcasting, are already in digital format and do not need to be converted.

The signals are then retained in digital form throughout the 861 until they are converted back to analogue form at the analogue outputs, to drive power amplifiers. If you are using the 861 with Meridian DSP Loudspeakers, the signals remain in digital form until the last possible stage.

The architecture of the 861 allows for wide flexibility – future sources and formats can be handled by upgrading either software or cards.

Meridian MHR Smartlink and MMHR

The 861 Reference Digital Surround Controller incorporates the unique MHR SmartLink and MMHR multichannel links. The MHR SmartLink allows it to receive an upsampled 6-channel PCM stream from a compatible source such as the Meridian 800 Reference DVD/CD Player. The MMHR receives an 8-channel PCM stream from a compatible system such as the Meridian HD621 HDMI Audio Processor.

Meridian MHR Smartlink and Meridian MMHR obtain intelligent stream content information from the source, allowing the 861 Reference Digital Surround Controller to select an appropriate preset depending on whether the source is music or a movie soundtrack, and whether it is 2-channel or multichannel.

Inputs

The 861 is a full-system controller preamp that provides seamless control of up to 12 sources.

By providing digital as well as analogue inputs the 861 can give radically higher sound quality for sources that are originally digital – like CD, Digital Radio and DVD.

As well as accepting 2-channel or multichannel digital audio, the 861 will handle SPDIF-encoded Dolby Digital, DTS, or MPEG from sources like DVD, Satellite, and BluRay.

Processing

The Meridian 861 routes all signals – if necessary via a 24-bit A/D converter – into the digital domain for processing in the highly developed Meridian DSP cards.

The incoming signals are processed using a variety of proprietary algorithms, and up to eight output signals are generated. These output signals can be used to feed a number of speaker layouts, ranging from two to eight loudspeakers.

The on-board algorithms include Meridian's own highly transparent Dolby Pro Logic, PLII, Dolby Digital, MPEG Surround, DTS, THX extensions, TV Logic, and a variety of award-winning music programs including Trifield and Ambisonic.

Outputs

The eight outputs can be provided as digital signals to feed Meridian DSP Loudspeakers, or as variable analogue outputs using a proprietary on-board 24-bit resolution conversion method.

Room Correction

The Meridian 861 can be used in conjunction with the Meridian Configuration Program to create a set of one or more room correction profiles matched to your room. A profile can then be selected to compensate for room artefacts, including resonances and reflections, or for imbalances between the speakers, to give a significant improvement in the sound.

DSP presets and layouts

The 861 provides an extensive range of options for decoding and processing analogue and digital signals for multichannel reproduction.

Music on CD or radio

The following DSP presets add a surround dimension to stereo recordings, such as on audio CDs or radio.

Music extracts the mono and surround components of the original recording for the centre and surround speakers to give a spacious open sound field.

Trifield is similar to **Music** but generates a centre-front signal that is completely integrated with the front stereo image, for a more stable, accurate, and focused stereo image. The image width is also adjustable.

Super produces a very good surround effect with many live recordings.

PLIIX Music and **Music Logic** are recommended for use with studio produced music, and provide different options for adjusting the sound field.

Two-channel movie soundtracks on DVD, video, and TV

Many movie soundtracks are Dolby Surround Encoded onto a two-channel stereo soundtrack.

The following DSP presets re-create the surround components from this type of material:

PLIIX Movie is Dolby's recommended choice for Dolby Surround Encoded material, and **PLIIX THX** provides a variant of this better suited to home listening.

TV Logic uses the same processing techniques as **PLIIX Movie** but with adjustable steering to give better results with TV material.

Special presets for two-channel materials

Direct uses only the left and right speakers; compare this with the effect of surround processing using the other modes. **Stereo** will use a subwoofer if it is present.

Ambisonics is specially designed for two-channel materials that are UHJ Ambisonically encoded, such as certain audio CDs. The encoded surround information is recovered and played back using all the loudspeakers in your system. In addition it will give impressive results with other two-channel material.

Multichannel movie soundtracks on DVD

The following presets are designed for use with multichannel movie soundtracks encoded using Dolby Digital or DTS. Typically these are labelled 5.1 because they provide five full-range channels (three front and two rear) and one LFE (bass effects) channel.

Cinema and **THX** decode the soundtrack to render the original six channels to your speaker layout. **THX** adds some additional signal processing to match the sound to typical home listening conditions.

PLIIX Mov6, **PLIIX Mus6**, **THX Surround EX**, **THX Ultra2**, and **THX Music** create an additional pair of surround channels from the 5.1 channel soundtrack and are available if you have four surround speakers in your system. Use **PLIIX Mus6** or **THX Music** for music.

Multichannel music recordings

The following presets are recommended for music recordings containing more than two channels:

Discrete renders the source channels to your speaker layout with the ultimate precision and transparency.

Ambisonics is especially designed for multichannel recordings on DVD-Audio discs that use Ambisonic encoding.

Speaker layouts

The surround controller provides great flexibility in the way in which you use the loudspeakers in your system. With the Meridian Configuration Program you can specify three different speaker layouts, each with a different use of subwoofers and centre speaker:

Layout	DSP presets
Music	For music presets: two-channel (eg Trifield) and multichannel (eg Discrete).
Logic	For two-channel movie presets: eg PLIIX Movie.
5.1 Movie	For multichannel movie presets: eg Cinema.

Specifications

Audio in and out

- Up to 12 analogue inputs. User-adjustable sensitivity. Re-nameable legends.
- Up to 12 digital inputs. Re-nameable legends. 32 to 96kHz sampling, and up to 24-bit precision.
- Up to 8 digital outputs.
- Up to 8 analogue outputs.
- Up to 4 configurable 6-channel analogue inputs.

Control signals

- 3 trigger outputs, programmable by source.
- Meridian Comms and RS232 for control and setup.

Controls, etc.

Front-panel facia controls for:

- Source, DSP, Mute, Volume, and Off.

Hinged control panel provides additional switches for:

- Display, Copy, Store, parameter menus, Assign, Calibrate, and Configure.

Display

- 20-character dot-matrix display: adjustable brightness and contrast.
- Lights for Dolby, Digital, THX, DTS, and MPEG.

Using the 861 Reference Digital Surround Controller

This chapter provides a summary of the functions of the 861 Reference Digital Surround Controller to identify the controls which you use to operate the unit.

It also provides step-by-step instructions for operating the digital surround controller, using either the front panel or the MSR+.

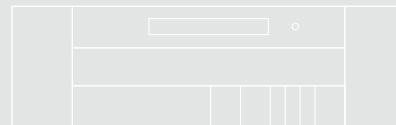

Front panel keys

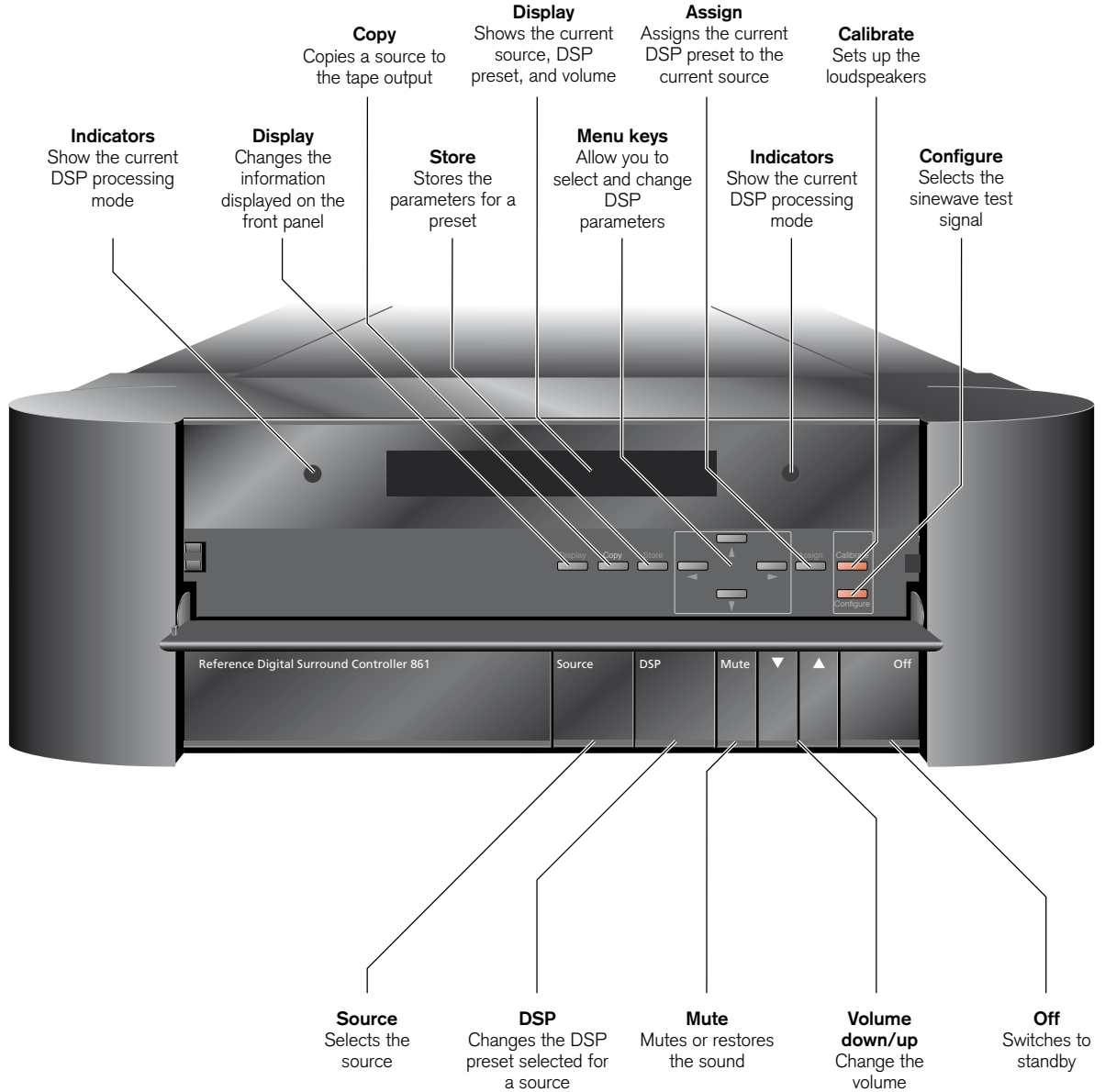

MSR+ keys

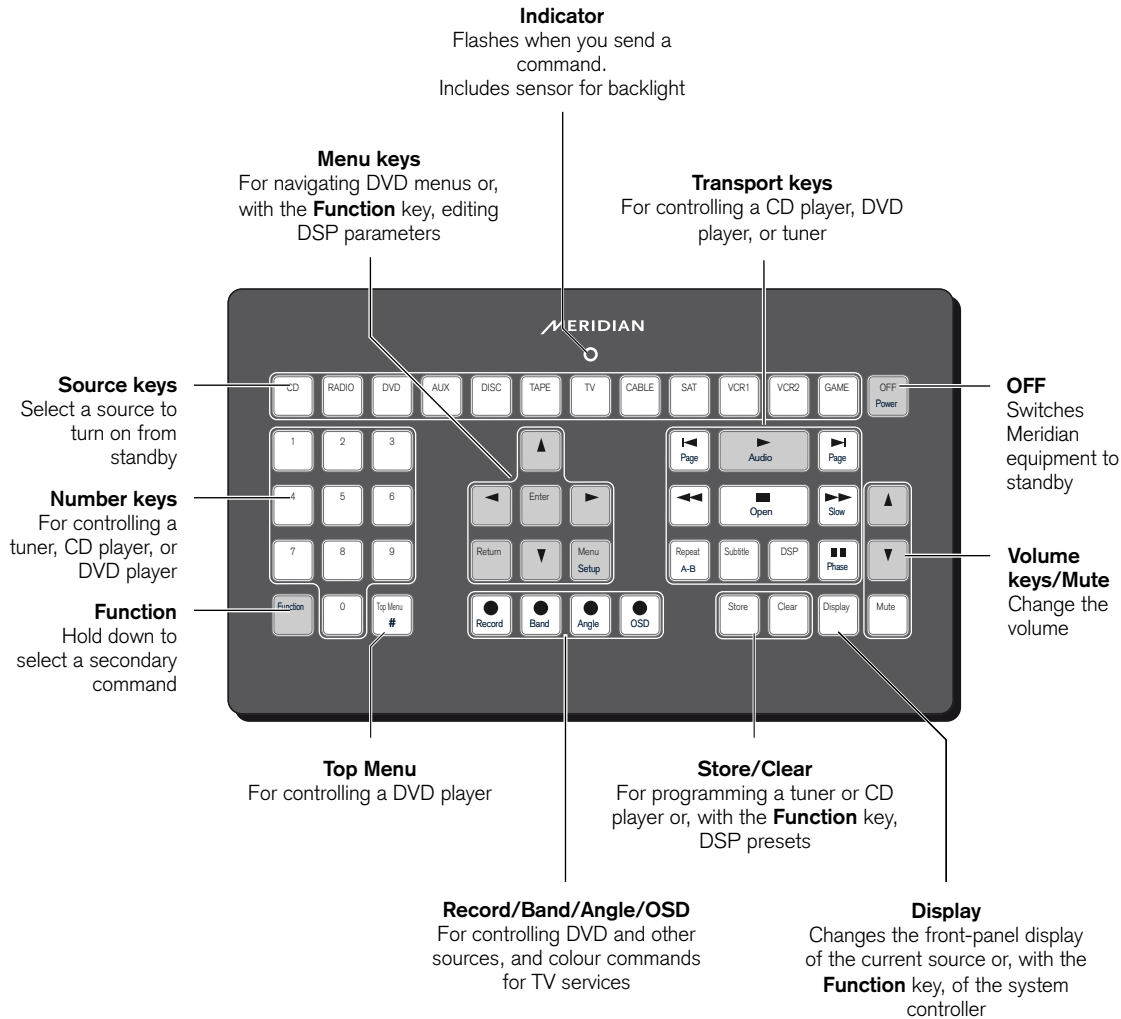

Switching on and off

When not playing, the digital surround controller should be left in the standby state. This ensures that the components of the digital surround controller operate at maximum efficiency from the moment you start.

If you are not going to use the digital surround controller for several days you should switch the unit off completely at the rear panel, and disconnect it from the AC power supply.

To switch on from standby

- Press **Source** (front panel), or select a source by pressing the appropriate source key on the remote; eg **CD**.

If the digital surround controller is part of a Meridian system it will automatically switch on any other unit in the system, such as the 800 Reference DVD/CD Player and Meridian DSP Loudspeakers.

To switch to standby

- Press **Off** (front panel or remote).

If you have other Meridian equipment or Meridian DSP Loudspeakers connected to the digital surround controller these units will also switch to standby.

Selecting a source

The digital surround controller provides the following 12 sources:

CD, Radio, DVD, Aux, Disc, Tape, TV, Cable, Sat, VCR1, VCR2, and Game.

The input and DSP preset associated with each source depends on how the digital surround controller has been set up; for more information see *Setting up sources*, page 51.

Your installer may have customised the labels displayed for each source to suit your other equipment.

To select a source

- Press **Source** (front panel) until the display shows the source you want, or press the appropriate source key on the remote; eg **CD**.

The display shows the source, DSP preset, and volume setting.

For example, if you select the CD source:

The display shows:



CD Trifield 65

The 861 Reference Digital Surround Controller mutes the sound while you change source.

Adjusting the volume

The 861 Reference Digital Surround Controller adjusts the volume in precise steps of 1dB, where 9dB is equivalent to doubling the loudness. The current volume setting is displayed in dB on the front-panel display, and can be varied in the range 1 to 99dB. When you first connect power to the digital surround controller the volume is set to 65, which is similar to the mid-way position of the rotary volume control on a conventional preamplifier.

A setting of 87 corresponds to THX reference gain, the level at which film soundtracks are mixed.

For normal to high level listening you should expect to use volume levels in the range 60 to 90.

On a system with analogue outputs the volume on startup can be set using the Meridian Configuration Program. For details see the *Meridian Configuration Program Guide*, available separately.

To change the volume

- Press ▲ or ▼ (front panel), or the red ▲ or ▼ keys on the remote.

As you adjust the volume setting the display shows the current volume level.

For example:

A black rectangular display with white text showing 'CD Trifield 70'.

To mute the sound

- Press **Mute** (front panel or remote).

The display will show:

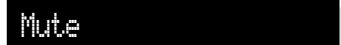
A black rectangular display with white text showing 'Mute'.

To restore the sound

- Press **Mute** again.

Alternatively, the sound will be restored if you adjust the volume.

Changing the DSP preset

Each source has a set of DSP presets associated with it, one for each of the alternative content types: Music 2 (2-channel music), Music 6 (multichannel music), Movie 2 (2-channel movie soundtrack), or Movie 6 (multichannel movie soundtrack).

When you choose a source, a DSP preset is selected depending on the incoming content type.

For example, if you have selected the CD source and are playing a conventional CD, the **Trifield** DSP preset will initially be selected.

You may then wish to choose a different DSP preset, such as **Music** or **Ambisonics**.

You can also change the default DSP preset assigned to the source; see *To assign a DSP preset to a source*, page 24.

The sequence of DSP presets for each content type is as follows:

Content type	Presets available
Music 2, Movie 2	Music, Trifield, Ambisonics, Super Stereo, Music Logic, PLIIx Music, Stereo, Direct, PLIIx Movie, PLIIx THX, TV Logic, Mono.
Music 6	Discrete, PLIIx Mus6, THX Music, Ambisonics B format.
Movie 6	Cinema, PLIIx Mov6, THX, THX Surround EX, THX Ultra2 Cinema.

In each case these will be followed by any user-defined presets you have stored for the appropriate content type.

To change the DSP preset

- Press **DSP** (front panel or remote) to step between the different DSP presets.

You will be able to choose any of the predefined DSP presets, or any user-defined presets you have stored.

The 861 Reference Digital Surround Controller mutes the sound while you change DSP preset, to avoid clicks in the speakers.

Changing the display

The 861 Reference Digital Surround Controller displays information about the current settings on the 20-character front-panel display. In addition, it can display the same information superimposed on a video image.

You can adjust the contrast and brightness of the front-panel display for optimum viewing, and choose what information is displayed.

The digital surround controller automatically stores these settings, even with the power off.

To change the contrast

- Hold down **Function** and press ► or ◀ on the remote, or press the corresponding menu keys under the front panel, until the display shows the current contrast setting.

For example:



- Hold down **Function** and press ▲ or ▼ on the remote, or press the corresponding menu keys under the front panel, to change the display contrast.

You can change the contrast between 0 and 15.

To change the brightness

- Hold down **Function** and press ► or ◀ on the remote, or press the corresponding menu keys under the front panel, until the display shows the current brightness setting.

For example:



- Hold down **Function** and press ▲ or ▼ on the remote, or press the corresponding menu keys under the front panel, to change the display brightness.

You can change the brightness between 0 and 15.

To change the displayed information

- Press **Display** (remote or under the front panel).

For example:





Each time you press **Display** the display will step between the options shown in the following table.

Display option	Example
Source, DSP preset, and volume.	DVD-A Ambisonics 65
Source, DSP preset, and THX reference level.	DVD-A Ambisonics -22
Audio format, no. of channels, content type, & sample rate.	DVD-A PCM Music6 44k
Blank.	

If the Diagnostic display option has been selected, additional diagnostic displays are included; refer to the Meridian Web site at www.meridian-audio.com for details.

In addition, the following symbols on the front-panel display indicate which of the DSP processing modes are operating, or what the original format was if received via the Meridian MHR Smartlink:

Symbol	What it means
	Dolby processing is operating.
DIGITAL	Input is Dolby Digital.
	THX processing is operating.
	Input is DTS.
MPEG	Input is MPEG.

Customising the 861 Reference Digital Surround Controller

In addition to being able to change the source, volume, and DSP preset, the 861 Reference Digital Surround Controller provides a sophisticated range of more advanced adjustments for each DSP preset, to allow you to tailor the sound.

This chapter explains how to change these parameters, using the menu keys on the remote or under the front panel, and gives detailed instructions for adjusting common parameters.

For information about the parameters specific to individual presets see the chapter *DSP presets*, page 27.

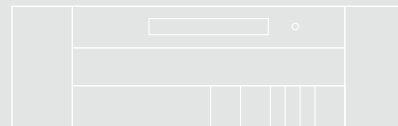

Locking and unlocking the menus

To simplify the normal operation of the digital surround controller, and to protect the settings from accidental changes, you can lock the menus so that the DSP parameters cannot be accessed.

The only parameters available with the menus locked are **Brightness** and **Contrast**.

To display or change the DSP presets, or to define your own presets, you first need to unlock the digital surround controller menus.

To unlock the menus

- Press **Off** (front panel or remote) to put the digital surround controller in standby.
- Press and hold down the **Store** button under the front panel for a few seconds.

The display shows:



Unlocked

To lock the menus

- Repeat the above sequence.

The display shows:



Locked

Changing the DSP parameters

Each DSP preset provides a series of parameters that you can vary to customise the behaviour of the preset to your specific requirements. For example, most presets provide **Balance** and **Depth** parameters to allow you to alter the characteristics of the sound.

For each of the built-in DSP presets these parameters are set to standard values, designed to give the best sound in typical listening conditions and with most source materials. Each time you select a different DSP preset the parameters are reset to these standard values, even if you have previously altered them.

You can save the changes you have made to one or more DSP parameters in place of the original DSP preset. Alternatively you can create a new user-defined DSP preset with a name of your choice. User-defined presets appear in the list of DSP presets after the built-in ones. For more information about doing this see *Defining your own presets*, page 25.

Standard parameters

All DSP presets (except Mono, Stereo, and Direct) provide the following standard parameters:

Parameter	Range	Default	What it changes
Treble*	-10dB to +10dB	+0.0dB	The slope of the frequency response.
Bass*	-5dB to +5dB	+0.0dB	The bass response.
Phase*	+ or -	+	The absolute phase.
Axis†	-2 to +3	-1	The vertical balance.
Balance	<10 to 10>	<0>	The L-R balance.
HS Out?*	Y or N	Y	Select Y for high-rate audio, upsampled if necessary. Select N for standard-rate audio, downsampled if necessary.
Centre	-3.0dB to +3.0dB	+0.0dB	The level of the centre.
Depth	-2.5ms to +5ms	+0.0ms	The delay of the centre.
Rear	-30dB to +10dB	+0dB	The level of the rears.
Sides	-30dB to +10dB	+0dB	The level of the sides.
R Delay	0ms to 30ms	Varies	The delay of the rears.
S Delay	0ms to 30ms	Varies	The delay of the sides.
LipSync	0ms to 50ms	0ms	The sync. delay.
RC	As defined	Bypassed	The Room Correction profile, or Bypassed for no room correction

* These parameters apply to all DSP presets.

† Axis is only available with Meridian DSP loudspeakers.

Individual DSP presets provide additional parameters, to allow you to adjust specific features provided by that preset. For full details refer to *DSP presets*, page 27.

Note: Parameters not relevant to your configuration, such as **Sides** in a five-speaker system, are omitted from the sequence of menus.

To change a DSP parameter

- Make sure the menus are unlocked; see *To unlock the menus*, page 16.
- Press ► or ◀ (remote or under the front panel) until the display shows the name of the parameter you want to change.

For example:



CD Depth +0.0

- Press ▲ or ▼ (remote or under the front panel) to change the value of the parameter.

As you change the value you will be able to hear the effect on the sound, and the display will show the current value. After a short delay the display will revert to the normal display of DSP preset and volume.

Changing treble, bass, or phase

The digital surround controller provides sophisticated treble and bass controls, to allow you to adjust the broad balance of the system to correct for the acoustics of your listening room, or for a misbalanced recording.

The controls are more subtle than conventional tone controls, and take advantage of digital signal processing techniques to provide a more natural adjustment of the frequency response.

You can also change the absolute phase of the signal, to compensate for recordings which are out of phase.

In each case all the outputs of the digital surround controller are given the same frequency adjustment, to ensure a correct surround effect.

*If you have a Meridian DSP Loudspeaker the **Treble** and **Bass** settings apply to all DSP presets.*

To change the treble

- Press ◀ or ▶ until the display shows the current treble setting.

For example:

CD Treble +0.0

- Press ▲ or ▼ to change the treble.

The treble control tilts the frequency of the response over the entire frequency range to make the sound more or less bright. It can be adjusted between ± 10 dB in 0.5dB steps. Normally settings between +1.0 and -2.0 will give the most natural results.

To change the bass

- Press ◀ or ▶ until the display shows the current bass setting.

For example:

CD Bass +0.0

- Press ▲ or ▼ to change the bass.

The bass control allows you to adjust the bass response in the room by ± 5 dB in 0.5dB steps. Normally settings between +3.0 and -2.0 will give the most natural results.

To change the absolute phase

- Press ▶ or ◀ until the display shows the current phase.

For example:

CD + Phase

- Press ▲ or ▼ to change the phase.

Changing the listening position

A conventional stereo system provides a single balance control, which changes the relative loudness of the two speakers. The 861 Reference Digital Surround Controller provides a more sophisticated adjustment which corresponds to moving the listening position to the left or right.

The axis control allows you to adjust the optimum listening height of the loudspeakers, like a balance control operating in the vertical plane. This option is only available with Meridian DSP loudspeakers.

You can also change the level of the centre, side, and rear loudspeakers relative to the main speakers.

To move the listening position to the left or right

- Press ◀ or ▶ until the display shows:

```
CD Balance <0>
```

- Press ▲ or ▼ to move the listening position.

The display shows the direction and position of the listening position.

For example:

```
CD Balance <3>
```

The arrow indicates the direction, and the number indicates the position where 0 is central, 8 is in line with the corresponding main speaker, and 10 is fully to one side.

Note: This adjustment is not available for the **Mono** preset.

To change the axis

- Press ◀ or ▶ until the display shows the current axis setting.

For example:

```
CD Axis -1
```

- Press ▲ or ▼ to change the axis.

The axis can be adjusted between -2 and +3, where 0 corresponds to the axis of the treble unit. Usually a listener will be below that position, so we recommend settings of -1 or -2.

To change the relative level of the side or rear loudspeakers

- Press ◀ or ▶ until the display shows the speakers you want to adjust.

For example:

```
CD Rear +0dB
```

- Use ▲ or ▼ to change the relative level of the speakers, in dB.

You can change the relative loudness of the rear loudspeakers from -30dB (about one-eighth of the loudness) to +10dB (about double the loudness).

For example, to double the loudness of the loudspeakers:

- Adjust their level until the display shows:

```
CD Rear +10dB
```

Note: This adjustment is not available for the **Direct**, **Stereo**, or **Mono** presets.

Changing the integration of the centre

If you have a centre loudspeaker you can adjust its relative loudness, to provide the best integration of the centre with the main left and right speakers.

You can also adjust the relative delay, or depth, of the centre speaker to give the best perspective between the three front speakers.

Note: These adjustments are not available for the **Direct**, **Stereo**, or **Mono** presets.

To change the relative level of the centre speaker

- Press ► or ◀ until the display shows the current centre level.

For example:

A digital display with a black background and white text. The text reads 'CD Centre+0.0dB'.

- Press ▲ or ▼ to change the relative level of the centre speaker.

You can change the relative level by $\pm 3\text{dB}$.

To change the relative delay of the centre speaker

- Press ◀ or ► until the display shows the current centre depth.

For example:

A digital display with a black background and white text. The text reads 'CD Depth +0.0'.

- Press ▲ or ▼ to change the relative depth of the centre speaker.

You can change the depth between -2.5ms , which corresponds to moving the centre speaker 0.75m ($2\frac{1}{2}'$) nearer to the listening position, and $+5\text{ms}$, which corresponds to moving it 1.5m ($5'$) further away from the listening position.

*Increasing the depth makes the sound more open.
Decreasing it makes the sound more focused.*

Changing the spaciousness of the sound

You can adjust the spaciousness of the sound by altering the delay on the rear and side channels.

Note: These adjustments are not available for the **Direct**, **Stereo**, or **Mono** presets.

To change the relative delay of the rear or side speakers

- Press ► or ◀ until the display shows the current rear delay.

For example:

A digital display showing the text 'CD R Delay 0.0' in a monospaced font. The 'CD' is on the left, 'R Delay' is in the middle, and '0.0' is on the right. The display is set against a dark background with a light border.

- Press ▲ or ▼ to change the relative delay of the rear speakers.

Increasing the delay by 1ms is equivalent to moving the speaker 0.3m (1') further away.

If you have side speakers an additional **S Delay** option allows you to adjust the delay on the side speakers.

*For best results you should never set the **S Delay** to be less than the **R Delay**.*

Changing the LipSync

To adjust the LipSync

The LipSync parameter is a feature originated by Meridian that allows you to adjust the delay between the sound and the video image by up to 50ms, or up to 85ms if Meridian Room Correction is not being used.

Most movies are mixed for a viewing distance of 9m (30'), and when viewed from 3.6m (12') or less the sound arrives too early, giving a disconcerting effect. Using the LipSync parameter you can add an overall delay to the sound to accommodate your closer home viewing distance.

Many TV broadcasts delay the picture by half a frame, and can benefit from a LipSync setting of 12ms.

Note: The LipSync setting is associated with a source rather than a DSP preset. The value set here will be applied whenever that source is selected, whatever the DSP preset.

- Press ► or ◀ until the display shows the current LipSync.

For example:

A digital display showing the text 'CD LipSync 0.0' in a monospaced font. The text is white on a black background.

- Press ▲ or ▼ to change the delay in milliseconds.

You can adjust the delay between 0 and 85ms, where 30ms corresponds to sitting 9m (30') further away from the screen.

Changing the DSP preset for a source

Each source has an appropriate DSP preset associated with it for each music format. For example, for a standard stereo (PCM) signal the CD source uses **Trifield** and the TV source uses **TV Logic**.

This section explains how to change the DSP preset associated with any source.

To assign a DSP preset to a source

- Make sure the menus are unlocked; see *To unlock the menus*, page 16.
- Select the source you want to change by pressing the **Source** key on the front panel or the appropriate source button on the remote, eg **CD**.
- If necessary, select a signal in the appropriate format. For example, to change the DSP preset used for DTS compact discs, play a DTS CD.

The display will show the source and the DSP preset currently assigned to that source.

For example:

A digital display with a black background and white text. The text is arranged in three columns: 'CD' on the left, 'Trifield' in the middle, and '65' on the right.

- Press ▲ or ▼ until the display shows the new DSP preset you want to assign.

For example:

A digital display with a black background and white text. The text is arranged in three columns: 'CD' on the left, 'MusicLogic' in the middle, and '65' on the right.

- Press **Assign** (under the front panel) to save the new assignment.

Defining your own presets

The 861 Reference Digital Surround Controller allows you to modify any of the built-in presets, and save them for future use.

You can either save the changes to the built-in preset, or you can create up to 10 presets of your own, with names of your choice, so you can use them alongside the built-in presets.

To save the preset settings

- Make sure the menus are unlocked; see *To unlock the menus*, page 16.
- Press **DSP** (front panel or remote) to select the preset you want to modify.
- Change the preset parameters to the values you want to store; see *To change a DSP parameter*, page 18.
- Press **Store** (remote or under the front panel).

The display shows the next available user-defined preset.

For example:



- If you want to overwrite an existing user-defined preset press **▲** to select the preset you want to overwrite.

For example:



Alternatively press **▼** to choose the built-in preset you started with.

For example:



- Press **Store** (remote or under the front panel).

The settings have been stored in the new or existing preset you selected.

If you are defining a user preset you can now edit the name of the preset if you wish.

- A flashing cursor shows the letter you are editing:



- Press **▶** or **◀** to select the character position you want to edit.
- Press **▲** or **▼** to change the character.

Each press steps through the sequence A to Z, a to z, 0 to 9, full stop, and blank. You can also select a blank directly by pressing **Clear** on the remote.

For example, you could change the name to:



- When you have entered the name you want to use press **Store**.

The display shows:



To make the new preset the default for the current source and audio format:

- Press **Assign** (under the front panel).

To clear a user-defined preset

- Make sure the menus are unlocked; see *To unlock the menus*, page 16.
- Press **DSP** (front panel) or **Preset** (remote) to select the preset you want to clear.
- Press and hold down **Clear** (remote) for several seconds.

The display shows:



If you clear a preset that was saved over a built-in preset, the original preset name and settings are restored.

DSP presets

This chapter gives technical information about each of the DSP presets built in to the 861 Reference Digital Surround Controller, including information about which preset you should select for different types of material. It also gives details of the special DSP parameters available for each preset.

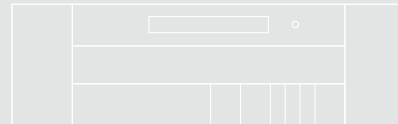

DSP presets for two-channel material

The digital surround controller provides several signal processing options for two-channel material. The Music DSP presets are designed for use with music from sources such as CD or radio:

- Music, Trifield, Ambisonics, Super Stereo, Music Logic, PLIIx Music, Stereo, and Direct.

The Logic DSP presets are designed for use with film soundtracks or TV programmes:

- PLIIx Movie, PLIIx THX, TV Logic, and Mono.

The Music and Logic DSP presets use the Music and Logic speaker layout respectively; see *Speaker layouts*, page 5.

Music

The Music DSP preset extracts the mono and surround components of the original recording. These components provide an alternative representation of the original sound, and this is sometimes used for recording systems or in broadcasts such as FM radio. The mono element is equalised using a proprietary Meridian technique to match the tone colour of the centre speaker, and to compensate for the fact that the frequency response of human hearing changes with direction.

The Music DSP preset is recommended for recordings made with spaced omnidirectional microphones, or using a mono-surround technique.

Trifield

As for the Music DSP preset, the Trifield preset extracts the mono and surround components of the original recording. It then calculates the signals for the front, left, centre, and right speakers, using the phase and amplitude differences between the three front channels, to redistribute the sounds on a frequency-dependent basis.

This gives a significant improvement over traditional

stereo, which converts the differences between the microphone signals into amplitude differences in the speaker signals. This version of the Trifield algorithm is virtually impossible to implement without digital signal processing.

Trifield is recommended for well-made recordings and stereo television broadcasts that are not Dolby Surround encoded. An advantage over the Music DSP preset is that the front stereo image is more focused, and the width of the image can be adjusted.

Music and Trifield DSP preset parameters

Parameter	Options	What it changes
Centre	Flat, EQ1–3	The timbre of the centre loudspeaker.
Width†	0–1.5	The width of the image.
Surr. Rear	Surr. Rear, Surr. Side, Surr. All	Switches the surround signal between the side and rear speakers.
R Filter	Off, 1kHz, 3kHz, 7kHz	The cutoff of high frequencies from the rear surrounds.
S Filter	Off, 1kHz, 3kHz, 7kHz	The cutoff of high frequencies from the side surrounds.

† Trifield only.

Ambisonics

The Ambisonics DSP preset can decode two-channel UHJ format, the stereo-compatible surround encoding found on Ambisonically-recorded discs and broadcasts. This material is specifically encoded for surround reproduction and can give breathtakingly realistic sound when replayed using the digital surround controller.

Ambisonic surround sound is quite unlike conventional stereo. A special microphone can be used to capture the sound of the original performance in all three dimensions, allowing a recording to be made in a special format (B-Format) that describes the soundfield exactly at the microphone position. Alternatively, special mixing techniques including Ambisonic spatial localisation controls (panpots) can be used to mix conventional multitrack into the same Ambisonic surround format. The channels of this recording can then be encoded using a phase-amplitude matrix (UHJ) to allow the surround information to be conveyed, typically via a two-channel medium such as disc or FM broadcast. On playback, the decoder reconstructs the soundfield captured by the original recording.

The digital surround controller uses accurately matched, frequency-dependent, phase-amplitude matrices to decode the signal and construct the signals for each speaker feed.

The fundamental difference between Ambisonics surround sound and conventional stereo is that the signals from all the speakers combine to produce a coherent soundfield at the listening position, giving the illusion that you are sitting inside the recording space whether you are at the exact central seat or well off to one side.

Of all the signal-processing options, Ambisonics is the one that requires the greatest attention to speaker choice and positioning.

Super

Super synthesises a signal from a conventional stereo recording or broadcast so that it can be decoded using the Ambisonic decoder. The result is especially effective for two particular types of recordings:

- Those using true coincident microphone techniques.
- Multi-tracked or multi-miked recordings.

Ambisonics and Super DSP preset parameters

Parameter	Options	What it changes
Width*	0 to 1	The width of the image.
Row†	A, C, E, G, I, K, M	The seating position; the letters are like rows in a hall.
Channels	7, 6, 5, 4	The number of speakers.
R Filter	Off, 3kHz, 7kHz, 9kHz	The cutoff of high frequencies from the rear surrounds.
S Filter	Off, 3kHz, 7kHz, 9kHz	The cutoff of high frequencies from the side surrounds.

* Super only.

† Ambisonics only.

MusicLogic

MusicLogic is a music DSP preset based on Pro Logic II with the addition of user-adjustable steering, designed to provide an exciting experience with many types of studio-produced music.

MusicLogic DSP preset parameters

Parameter	Options	What it changes
Roll	Off, Low, Med, Max	The degree of left-right steering.
Yaw	Off, Low, Med, Max	The degree of front-rear steering.
Steered All	Steered Rear, Steered Side, Steered All	Which of the four surround channels are generated by steering.

PLIIX Music

The PLIIX Music preset is designed to use the Pro Logic IIX DSP processing mode to decode music sources. It provides additional **Width**, **Dimension**, and **Panorama** preset parameters to allow you to adjust the soundfield.

PLIIX Music DSP preset parameters

Parameter	Options	What it changes
Steered All	Steered Rear, Steered Side, Steered All	Which of the four surround channels are generated by steering.
Width	0 to 7	The centre spread, where 0 is full centre and 7 is full left and right.
Dimension	-3 to +3	The spatial soundfield, where -3 puts the balance to the rear of the room and +3 puts it to the front.
Panorama	No, Yes	Extends the front stereo image to include the surround speakers, to give a wrap-around effect.

Stereo and Direct

The Stereo preset passes the left and right input signals directly to the left and right main speakers. Any mono or front left and right subwoofers continue to be used. With the Direct preset only the left and right main speakers are used, bypassing any spatial processing and bass management.

There are no additional DSP preset parameters for Stereo and Direct.

PLIIX Movie and PLIIX THX

PLIIX Movie and PLIIX THX use the Dolby Pro Logic IIX DSP processing mode, and are the recommended choice for Dolby Surround encoded material. They also give excellent results with two-channel sources not specifically encoded for Dolby Surround, including two-channel Dolby Digital sources.

Pro Logic IIX re-creates 7.1-channel movie surround from the two-channel source, using improved decoding techniques that preserve the directness of the soundfield, resulting in enhanced image stability compared with the original Pro Logic decoding. Meridian's implementation of Pro Logic IIX uses proprietary code based on 48-bit precision to give outstanding clarity.

The PLIIX THX DSP preset uses the same PLIIX processing as PLIIX Movie, but adds THX Cinema processing. THX is a set of standards and technologies developed by Lucasfilm Ltd. with the aim of making your experience of the film soundtrack as faithful as possible to what the director intended.

Re-equalisation is used to restore the correct tonal balance for watching a film soundtrack in a small home environment. The information going to the surround speakers is filtered so that it closely matches the tonal characteristics of the sound coming from the front speakers, to ensure seamless panning between the front and surround speakers.

THX can also be used with the 5.1 Movie DSP presets; see *THX*, page 33.

PLIIx Movie and PLIIx THX DSP preset parameters

Parameter	Options	What it changes
Surrounds	Rear, Side, All	Which of the four surround channels are generated by steering.
Pro Logic	Off, On	On selects an emulation of the original Pro Logic decoding.

TV Logic

TV Logic is a Logic preset based on Pro Logic IIx with the addition of user-adjustable steering, designed to give higher intelligibility and a more appropriate spatial presentation for studio-based TV material.

TV Logic DSP preset parameters

Parameter	Options	What it changes
Roll	Off, Low, Med, Max	The degree of left-right steering.
Yaw	Off, Low, Med, Max	The degree of front-rear steering.
Surrounds	Rear, Side, All	Which of the surround channels are generated by steering.

Mono

In the Mono DSP preset you can choose to listen to:

- Only one of two input channels, such as when different languages or material are carried on each channel.
- A combined version of the two input channels, such as if the material was originally mono and has been conveyed on a two-channel carrier.

If **Party?** is set to **No**, the combined or selected signal is played only through the centre speaker, or the left and right speakers if there is no centre, to centrally localise high-frequency hiss and clicks.

Note: If **Party?** is set to **Yes**, full range bass is played through any speakers that are not supplemented by a subwoofer, and this may damage small speakers at high volume levels.

Mono DSP preset parameters

Parameter	Options	What it changes
Input	Auto L+R, Input L, Input R, Input L+R	The channel selected.
Academy	Off or On	Select On to include an equalisation (recommended by Lucasfilm Ltd) to correct for a high-frequency balance in some old mono films.
Party?	No or Yes	Select Yes to play the mono signal through all speakers, including subwoofers.

DSP presets for multichannel material

Multichannel audio signals can come from either encoded data streams (such as Dolby Digital) or as discrete channels from a DVD player. If you are using Meridian SmartLink then all formats will reach the 861 as discrete channels. With suitable loudspeakers the 861 can upsample these to provide a more enjoyable surround experience.

The 861 Reference Digital Surround Controller will automatically select the right decoder algorithm and present the same set of preset choices for all streams.

Note: Some presets are only available if there are four surround speakers in the system.

There are four multichannel Music presets:

- Discrete, PLIIx Mus6, THX Music, and Ambisonics B format (discrete inputs only).

There are five multichannel Movie presets:

- Cinema, PLIIx Mov6, THX, THX Surround EX, and THX Ultra2 Cinema.

The multichannel Music presets all use the Music speaker layout and the multichannel Movie presets all use the 5.1 Movie speaker layout; see *Speaker layouts*, page 5.

Cinema

The Cinema preset is recommended for listening to multichannel movie soundtracks when no further processing is required.

Discrete

The Discrete preset is similar to Cinema, except that it uses the Music speaker layout and sets the LFE level to -10dB.

Discrete and Cinema DSP preset parameters

Parameter	Options	What it changes
2+2+2*	Off, 5.1, Side, 7.1	Allows you to specify how DVD Audio channels 3+4 should be interpreted: Off ignores them, 5.1 and 7.1 use them for centre and LFE, Side uses them for the side speakers, 7.1 adds side speakers to 5.1.
Surround†	Surr. Rear, Surr. Side, Surr. All	Allows you to specify which speakers the surround channels should be sent to in a system with four surrounds.
R Filter	Off, 1kHz, 3kHz, 7kHz	The cutoff of high frequencies from the rear surrounds.
S Filter	Off, 1kHz, 3kHz, 7kHz	The cutoff of high frequencies from the side surround.
LFE	-28dB to 0dB	The relative level of the LFE bass channel.

* Discrete only.

† Cinema only.

THX

As with the PLIIx THX DSP preset, THX re-equalises the signals to suit domestic listening conditions, and applies frequency-response correction and decorrelation to the surround channels to make the surround sound more realistic. It can be used whether or not your other equipment is THX approved.

THX DSP preset parameters

Parameter	Options	What it changes
Surround	Surr. Rear, Surr. Side, Surr. All	Switches the surround signal between the side and rear speakers.

PLIIx Mov6, THX Surround EX, PLIIx Mus6, THX Ultra2 Cinema, and THX Music

These presets are available if you have four surround speakers. They use Dolby Pro Logic IIx, Dolby Surround EX, and THX Ultra2 Cinema processing to generate multiple signals for larger home theatres.

PLIIx Mov6 uses extended PLII technology from Dolby to generate four surround signals from traditional multichannel source material like Dolby Digital 5.1. It is intended for use with movie soundtracks.

PLIIx Mus6 also creates four surround signals; it is intended for multichannel music playback from sources such as DVD-A or SACD music discs.

THX Ultra2 Cinema and THX Music use a THX proprietary process called advanced speaker array to provide a mix of ambient and directional surround sounds using four surround speakers. Optimum performance of THX Ultra2 Cinema and THX Music is produced when the two rear speakers are placed close together behind the listening position. THX Ultra2

Cinema is recommended for movie soundtracks that are not Dolby Surround EX encoded, and THX Music is recommended for listening to multichannel music.

PLIIx Mov6, THX Surround EX, PLIIx Mus6, THX Ultra2 Cinema, and THX Music preset parameters

Parameter	Options	What it changes
LFE	-28dB to 0dB	The relative level of the LFE bass channel.

Ambisonics

The Ambisonics preset allows you to decode multichannel sources which have been encoded in Ambisonics B format.

Ambisonics B format contains four independent channels of information to give a three-axis representation of the sound at the recording position. The signals are: mono sound pressure, left-right velocity component, front-back velocity component, and up-down velocity component.

Using dynamic range control

If the input format is Dolby Digital, the 5.1 Movie DSP presets provide an additional **Compress** parameter to allow you to take advantage of the dynamic range information provided in the Dolby Digital format to provide dynamic range control without the distortion involved in analogue methods.

The **Compress** parameter allows you to set one of the following options:

Option	Description
Compress off	No compression.
Quiet boost	Provides a moderate amount of bottom-up compression. This raises quiet sounds above the background noise, which is ideal for demonstration and quiet listening.
Compress med	Provides moderate amounts of both bottom-up and top-down compression.
Loud cut	Provides a moderate amount of top-down compression. This reduces loud sounds.
Compress max	Provides full bottom-up and top-down compression. Quiet sounds are raised to be audible and loud passages are minimised to avoid disturbance, which is useful for late-night listening.
Compress mix	Bypasses dialogue normalisation and references the sound pressure level in the studio where the material was mixed

Dialogue Normalisation display

Dolby Digital audio streams include Dialogue Normalisation and Mix levels, to specify the recommended listening level of the soundtrack.

The surround controller uses the Dialogue Normalisation level to adjust the volume level so that the soundtrack is reproduced at the correct absolute level, assuming the system is calibrated to produce 75dB SPL at volume 87.

The Mix level is an alternative level which you can select by setting the **Compress** parameter to **Compress mix**.

The Dialogue Normalisation or Mix level is shown in a separate display option for Dolby Digital sources:

For example:

```
DialNorm -31
```

Or:

```
MixLevel -27
```

Installing the 861 Reference Digital Surround Controller

This chapter explains how to install the 861 Reference Digital Surround Controller. It describes what you should find when you unpack the product, and how you should connect it to the other equipment in the system.

You should not make any connections to the product or to any other component in the system while the AC power supply is connected and switched on.

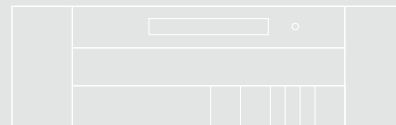

Unpacking

The 861 Reference Digital Surround Controller is supplied with the following accessories:

- MSR+ remote control with batteries, manual, and spare key caps.
- Meridian Comms lead.
- Power cord.
- This manual.

If any of these items are missing please contact your dealer.

NOTE: You should retain the packaging in case you need to transport the unit.

Back panel

The following diagram gives details of the back panel connections on a standard 861. Note that your unit may include optional cards to provide additional inputs and/or outputs:

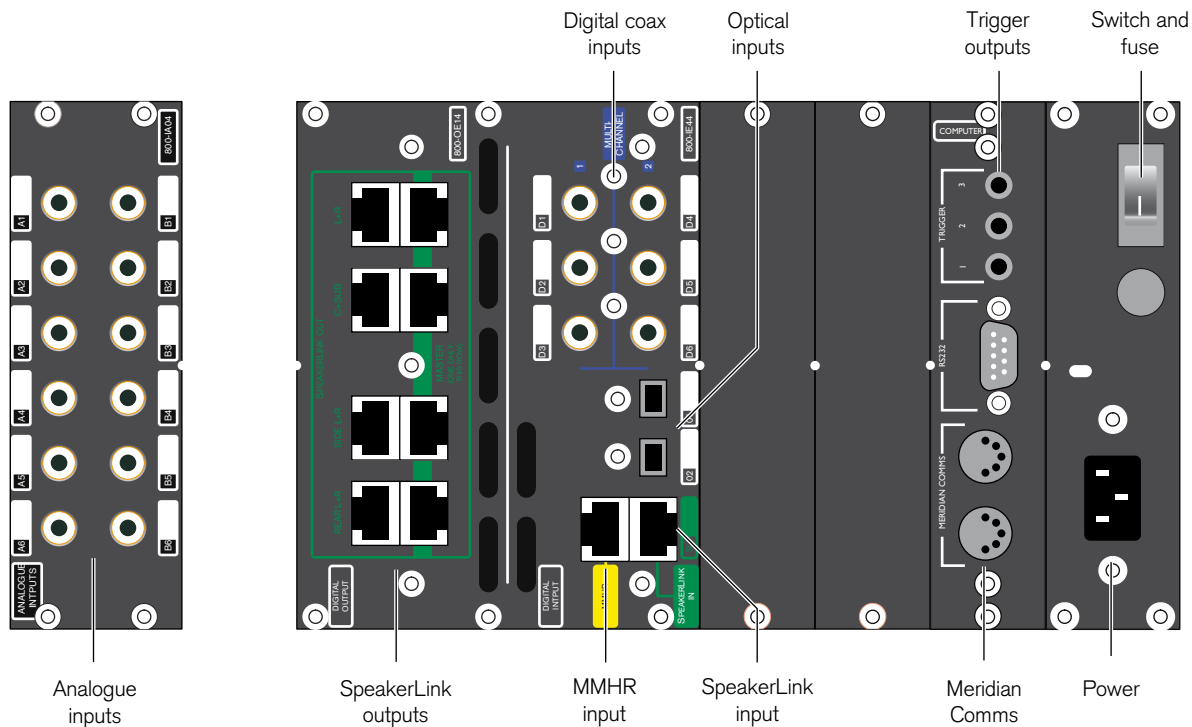

Standard and optional cards

The following diagram shows the cards supplied as standard to the 861, and the optional cards (shown in brackets):

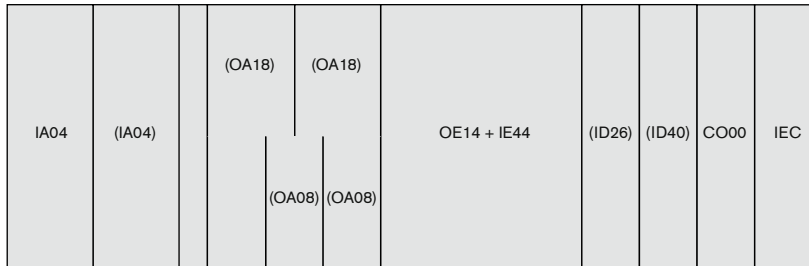

Analogue inputs – IA04

Use this output

A1 to A6 and B1 to B6*

To connect to this

The analogue outputs of a source, such as a TV or tape deck.

Extra analogue inputs – IA04 (optional)

Use this output

A1 to A6 and B1 to B6*

To connect to this

The analogue outputs of a source, such as a TV or tape deck.

* A1-A6 and B1-B6 can each be configured as a single 6-channel input.

Balanced outputs – OA18 x 2 (optional)

Use this output

1 to 4 and 1 to 4

To connect to this

The balanced analogue inputs of a preamplifier, or a power amplifier such as the G57, using XLR leads.

Unbalanced outputs – OA08 x 2 (optional)

Use this output

1 to 4 and 1 to 4

To connect to this

The unbalanced analogue inputs of a preamplifier, or a power amplifier such as the G57, using analogue phono leads.

SpeakerLink outputs – OE14

Use this output

L+R, C+SUB, SIDE
L+R, REAR L+R

To connect to this

Digital loudspeakers, using Meridian SpeakerLink leads or standard CAT5 network cables. The Master speaker must be connected to the appropriate socket on the right-hand column.

Digital inputs – IE44

Use this input	To connect to this
D1 to D6*	The digital output of a source such as a DVD player.
O1 and O2	The optical output of a source such as a satellite receiver or computer.
SL1	The SpeakerLink output of a Meridian source with a SpeakerLink output.
MMHR	A multichannel digital source with an MMHR output, such as the Meridian HD621 HDMI Audio Processor.

* D1-D3 and D4-D6 can each be configured as a multichannel digital input for MHR SmartLink sources.

Extra digital inputs – ID26 (optional)

Use this input	To connect to this
O3 to O6	The optical output of a source such as a satellite receiver or computer.
SL2 and SL3	The SpeakerLink output of a Meridian source with a SpeakerLink output

Sooloos connections – ID40 (optional)

Use this connection	To connect to this
Network	An Ethernet network, for use in a Sooloos system.
USB	For maintenance of the Sooloos software.

Communications connections – CO00

Use this connection	To connect to this
MERIDIAN COMMS	Other Meridian equipment, or Meridian DSP loudspeakers.
RS232	A computer, for configuring the 861, or a serial control system.
TRIGGER 1, 2, and 3	Equipment that can be triggered by a 12V 100mA signal.

Applications

To connect to a digital source (eg G06 24-bit CD Player)

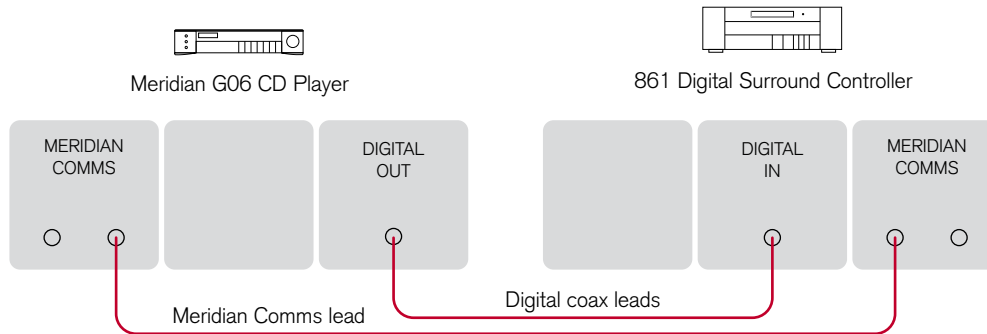

You can connect up to six digital coax sources to the 861 Reference Digital Surround Controller, or 12 with the optional ID26 card.

If the source is a Meridian product, connect together the COMMS sockets using the Comms lead provided.

- Connect the digital source to one of the digital input sockets, using a 75Ω screened coax phono lead.

To connect to an analogue source (eg TV tuner)

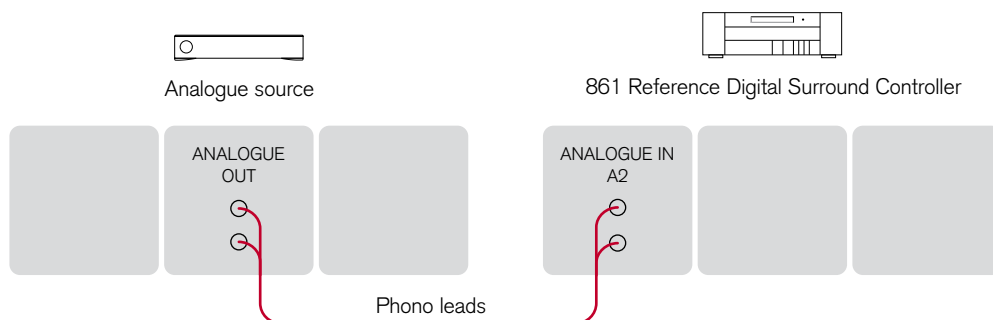

You can connect up to 12 analogue sources to the 861 Reference Digital Surround Controller.

- Connect the analogue source to one of the analogue input sockets of the digital surround controller, using screened coax phono leads.

To connect to a digital source using SpeakerLink (eg 808.3)

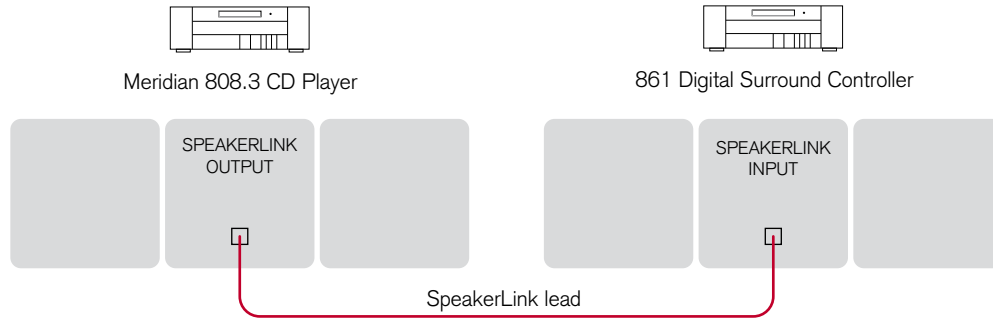

- Connect the DIGITAL output from the 808.2/808.2i to the SpeakerLink input on the digital surround controller, using a Meridian SpeakerLink lead.

To connect to a Meridian HD621 HDMI Audio Processor

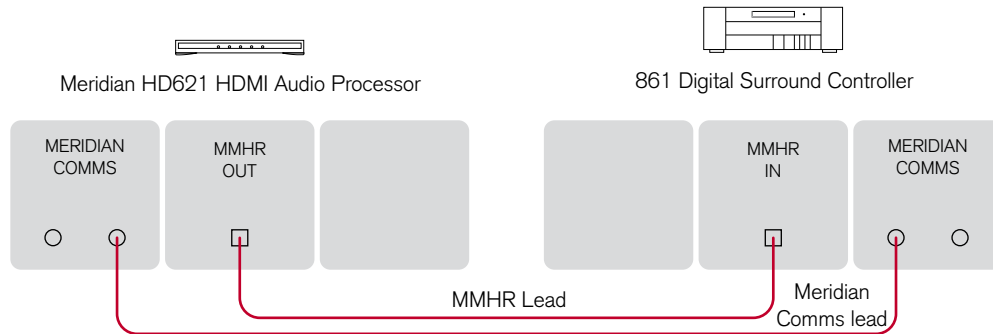

The 861 provides an MMHR multichannel input which can be used with the HD621 HDMI Audio Processor.

- Connect the MMHR output from the HD612 to the MMHR input on the 861, using an MMHR lead.

- Connect together the COMMS sockets using a Comms lead.

To connect to a source with analogue multichannel outputs (eg SACD player)

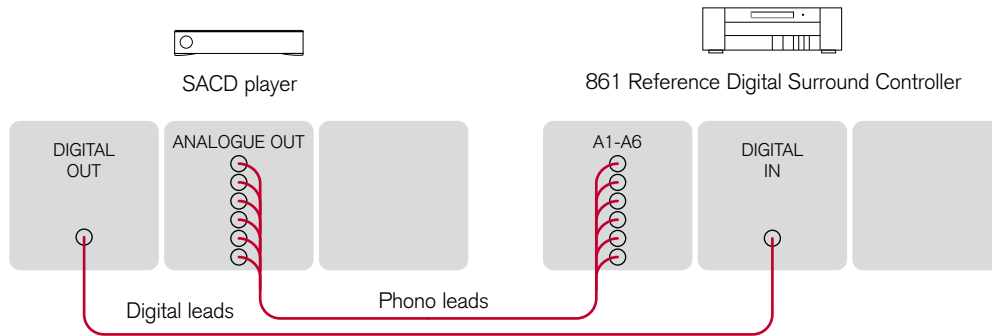

The 861 Reference Digital Surround Controller provides two sets of 6 analogue inputs, called A1-A6 and B1-B6. Each set can be used as a multichannel input from a source with a suitable analogue multichannel output, such as an SACD player.

- Connect the Left, Right, Centre, Sub, Left Surround and Right Surround sockets from the source to the A1, A2, A3, A4, A5, and A6 analogue inputs on the digital surround controller (or the corresponding B1-B6 inputs), using six phono leads.
- Optionally connect a digital output from the source to a digital input on the 861, using a digital phono lead.

You can then select the source corresponding to the multichannel input for playing surround material, and the source corresponding to the digital input to decode other formats.

Note: Multichannel analogue sources may have subwoofer level outputs that vary by up to 10dB, so it may be necessary to reduce the LFE level to give correct bass integration; see *DSP presets*, page 27.

To connect to DSP loudspeakers using SpeakerLink (daisy chain)

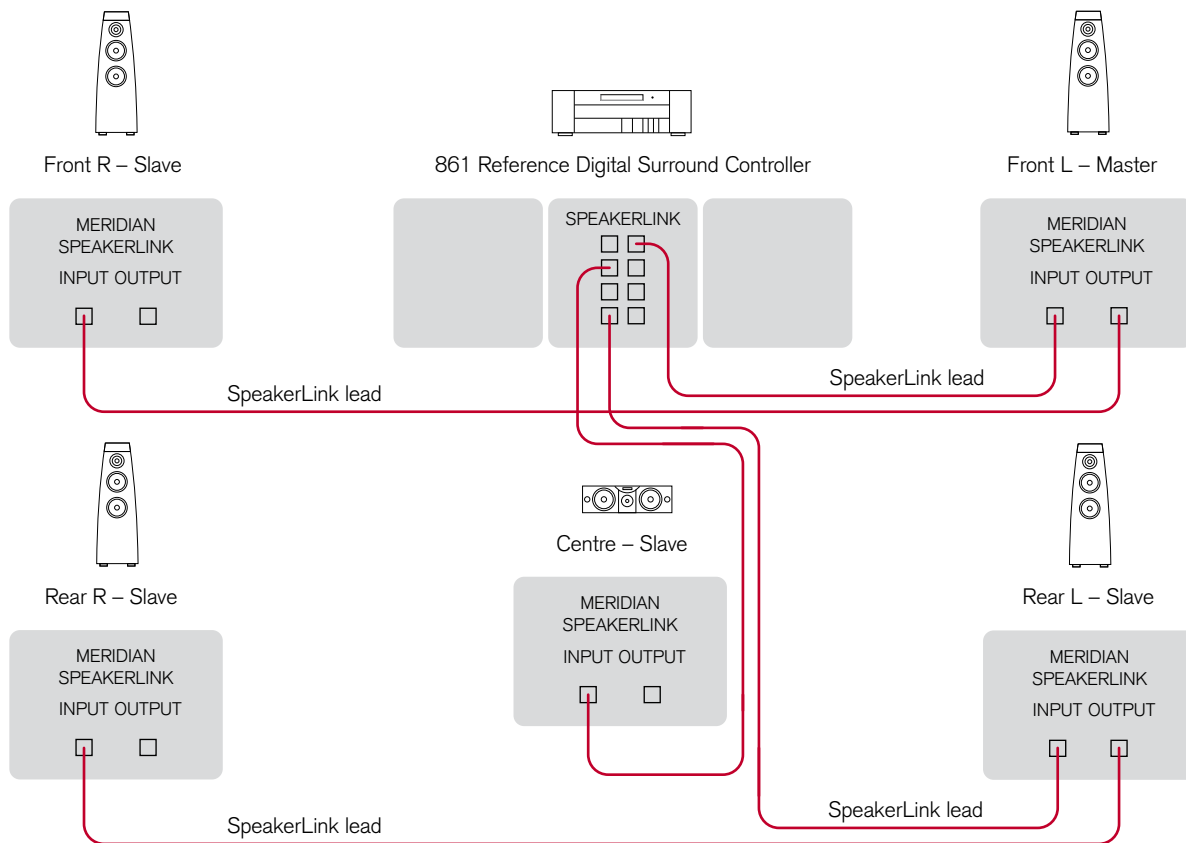

This is an alternative to the “home run” wiring configuration shown opposite.

- Connect the appropriate SpeakerLink output on the right-hand column of the 861 to the digital speaker you have chosen as the master (typically the front left speaker), using a Meridian SpeakerLink lead.
- Connect the appropriate SpeakerLink outputs on the 861 to one of each of the remaining pairs of speakers, using a Meridian SpeakerLink lead.

- Link each pair of speakers together with a Meridian SpeakerLink lead, out of the first speaker and into the second speaker, as shown in the diagram.

The speakers should then be configured appropriately as master and slaves, and Left, Right, Centre, Surround; see *Meridian DSP Loudspeaker User Guide* for more details.

Alternatively you can use standard CAT5 network cables instead of SpeakerLink leads.

To connect to DSP loudspeakers using SpeakerLink (home run)

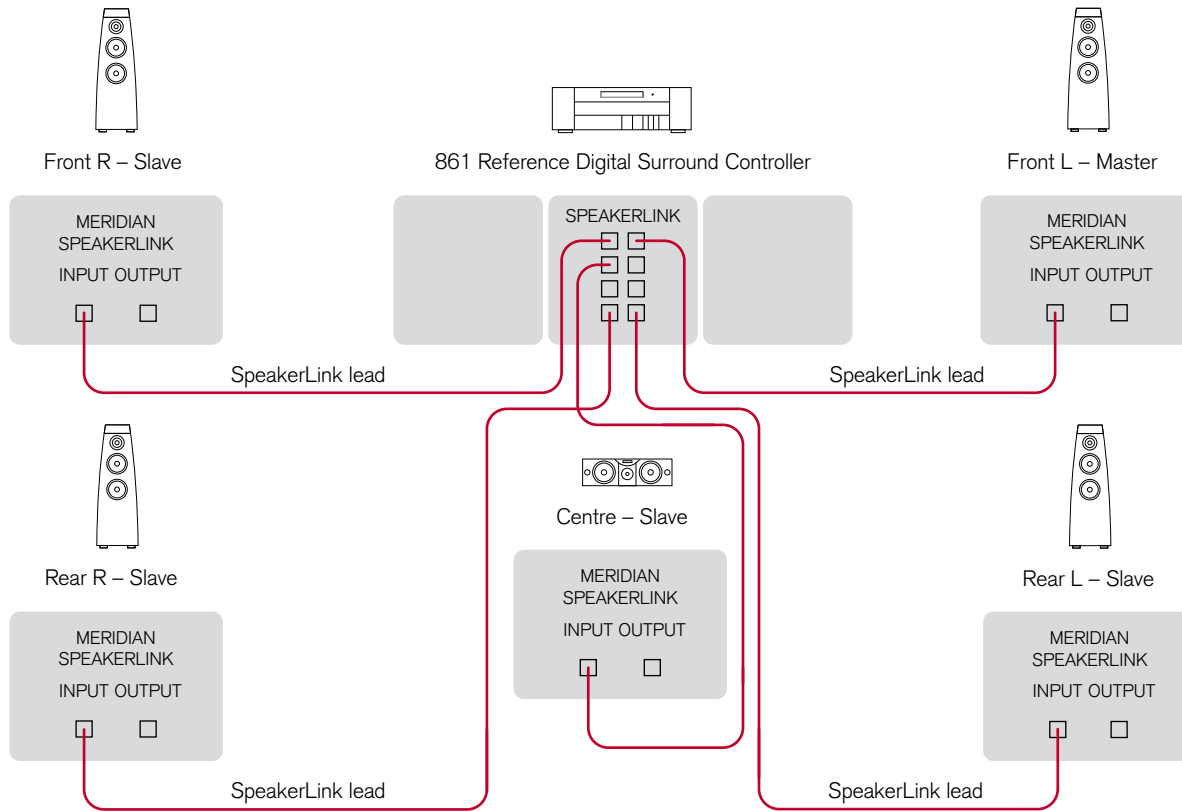

This is an alternative to the “daisy chain” wiring configuration shown opposite.

- Connect the appropriate SpeakerLink output on the right-hand column of the 861 to the digital speaker you have chosen as the master (typically the front left speaker), using a Meridian SpeakerLink lead.
- Connect the appropriate SpeakerLink outputs on the 861 to each of the remaining speakers, using a Meridian SpeakerLink lead.

The speakers should then be configured appropriately as master and slaves, and Left, Right, Centre, Surround; see *Meridian DSP Loudspeaker User Guide* for more details.

Alternatively you can use standard CAT5 network cables instead of SpeakerLink leads.

To connect to other Meridian G Series or 800 Series equipment

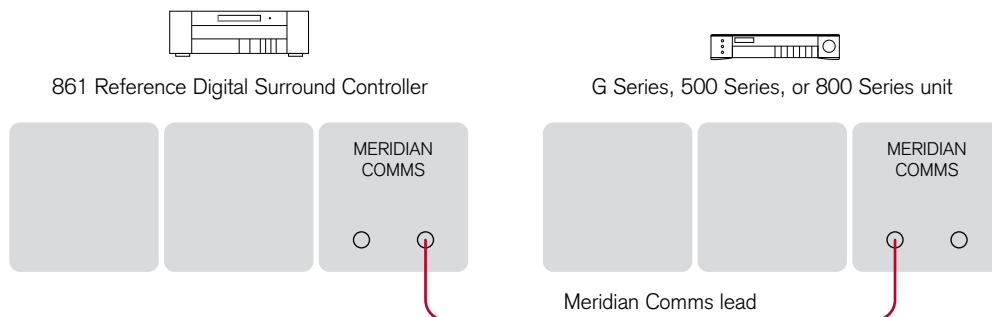

In a system of Meridian products, one of the products acts as the controller for the system, receiving infra-red commands from the MSR+ and then, if appropriate, relaying them to the other products via the Comms link.

The following automatic setup procedure should be used to set up the Comms correctly between several products:

Connect one of the DIN COMMS sockets on the back panel of the 861 Reference Digital Surround Controller to one of the COMMS sockets on another G Series, 500 Series, or 800 Series unit, using the Comms leads provided with the products.

The sequence in which you connect the units is not important.

- Switch all the units to standby.
- Press **Clear** (remote).

Each unit will display: **Auto**

One unit will then be designated as the controller.

The display shows: **Controller**

All the other units will be configured as non-controllers.

The displays show:

Not Con.

If for any reason the automatic setup does not work, make sure you are operating the remote from a position where all the units can receive the infra-red, and try again.

If this fails:

Restore the default operation by selecting one of the standard types; see *Choosing a standard setting*, page 46.

Do not, under any circumstances, connect any equipment other than Meridian G Series or 800 Series to any socket marked COMMS on the back of the product.

Configuring the 861 Reference Digital Surround Controller

This chapter explains how to set up the 861 Reference Digital Surround Controller for most standard configurations of loudspeakers and sources using just the front-panel controls and MSR+.

For complete control over all aspects of the digital surround controller's configuration, or to take advantage of Room Correction, it is recommended that you set up the unit using the Meridian Configuration Program; for full information see the *Meridian Configuration Program Guide*, available separately.



Choosing a standard setting

The digital surround controller provides six standard settings, called Types, which configure all aspects of the 861 into the most commonly needed configurations. In addition, any User Types you create using the Meridian Configuration program are also available.

Types 0 to 5 are factory settings, designed to cater for the most commonly needed configurations of associated equipment.

These standard Types are shown in the following table:

Type	Speakers	Music Sub	Logic Sub	5.1 Movie Sub
0	All analogue.	LFE	Centre	LFE
1	All analogue.	Mono	Mono	Mono
2	All digital.	LFE	Centre	LFE
3	All digital, large centre.	None	None	None
4	Digital left, right, and centre.	LFE	Centre	LFE
5	Digital left and right.	LFE	Centre	LFE

In this table Music Sub refers to a subwoofer used for all Music DSP presets, Logic Sub to a subwoofer used for all Logic DSP presets, and 5.1 Movie Sub to a subwoofer used for all 5.1 Movie DSP presets.

Choosing one of the Types overrides any other configuration you may have performed, and so can be used to reset the configuration of the unit. **Note:** Selecting a Type will clear any configuration and calibration changes you have made, or any DSP presets you have defined. It does not reset any Room correction profiles stored to the 861 using the Meridian Configuration program.

To select a standard setting

Warning: This procedure will reset any configuration and calibration changes you have made.

- Put the digital surround controller into Standby by pressing **Off** (front panel or remote).
- Hold down the ▲ key on the front panel until the display shows:



- Keep holding down the ▲ key for a further three seconds.

The display will show:



Then after a short delay the display shows the current Type.

For example:



- Press ▲ or ▼ on the front panel to change the Type number.

The display shows:



- Wait for one second, and then put the digital surround controller into standby by pressing **Off** (front panel or remote).
- Switch on again to use the standard settings you have selected.

Setting up the digital surround controller with other Meridian equipment

If you are using the 861 with other Meridian equipment, such as the 800 Reference DVD/CD Player, you should set up the Comms with the following automatic setup procedure:

- Switch all the units to standby.
- Press **Clear** (remote).

Each unit will display: **Auto**

The 861 will then be designated as the controller, and display:

Controller

This is the unit that will respond to the remote.

All the other units will be configured as non-controllers, and display:

Not Controller

Your system is now set up and ready for use.

If for any reason the automatic setup does not give the configuration you want, restore the default operation by selecting one of the standard Types; see *Choosing a standard setting*, page 46.

Calibrating the system

To help you to set up your installation to give the best possible sound with any particular combination of associated equipment, the 861 Reference Digital Surround Controller includes a built-in calibration procedure.

This calibration procedure uses test signals to present a series of sounds, which you use to adjust certain aspects of the system to their optimum settings.

You should work through the calibration procedure the first time you set up your surround sound system, and whenever you want to check the calibration, such as after changing the layout of your room.

Using the calibration procedure

We recommend that you perform the calibration procedure using the MSR+ from the listening position.

As you run the calibration procedure the name of each calibration test is shown on the front-panel display, followed by the parameters adjusted in the test.

Each calibration test uses a test signal designed to give the best results.

Using a Sound Pressure Level meter

Although you can perform the calibration procedure by ear, it is recommended that you perform the tests using a Sound Pressure Level meter.

Set the Sound Pressure Level meter to C weighted, 80dB range, and slow response. Take readings with the meter at the listening position, pointing vertically. You should hold the meter with an outstretched arm to minimise reflections from your body.

To start the calibration procedure

- Put the digital surround controller into standby by pressing **Off** (front panel or remote).
- Press and hold the **Calibrate** key, under the front panel, for at least five seconds.

The display shows:



After a few seconds the display shows:



For more detailed information about this and the other calibration tests see the following sections.

To move between the calibration tests

- Press **▶** (remote), or the corresponding menu key under the front panel.
- Press **◀** (remote), or the corresponding menu key under the front panel, to move back to an earlier test.

To jump to the next set of tests

- Press **Store** (front panel or remote).

The calibration tests are described in the following sections.

To exit from the calibration procedure

You can exit from the calibration procedure at any time, and any parameters you have set will be retained.

- Press **Off** (front panel or remote).

Calibration tests

Levels

These tests allow you to adjust the output level to each speaker individually, and it follows the general guidelines from Dolby Laboratories and Lucasfilm Ltd. A Sound Pressure Level (SPL) meter can be useful at this stage; see *Using a Sound Pressure Level meter*, page 48.

In each test the display shows the speaker being tested, and the current relative level.

For example:

Left Level +0.0dB

- Press **▶** or **◀** to move between each of the speakers in the layout in the sequence: Left, Centre, Right, Side R, Rear R, Rear L, Side L, and subwoofers.
- Press **▲** or **▼** to adjust the level of the speaker. Ignore any tonal difference.

For correct THX reproduction you should adjust each speaker to 75dB SPL using an SPL meter. Even if your speakers are not THX approved this setting is recommended.

Note: You cannot directly set the level of a subwoofer by ear, because low-frequency noises sound quieter. To set the subwoofer correctly either use an SPL meter, or set it by ear and then reduce the subwoofer gain by 15dB to correct for human hearing.

- When you have completed the Levels section press **▶** or **Store** to proceed to the next test.

Distance

These tests allow you to adjust the delay of each of the speakers in the layout to time-align the system so that sounds are coincident when they arrive at the listening position.

Before setting up the speaker outputs you need to measure the distance, in feet and inches, to each speaker from the listening position:

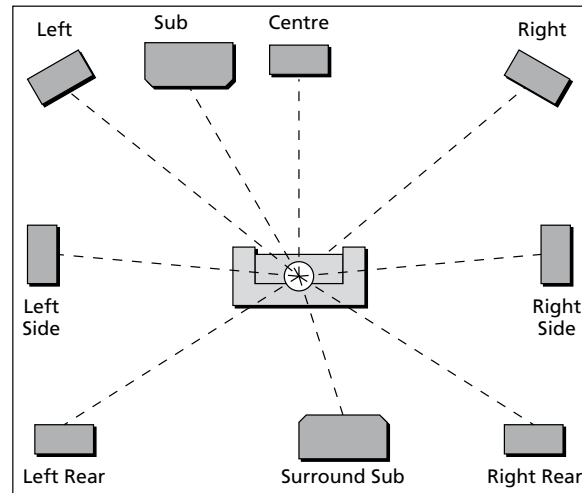

Measure from the ear height at the listening position to the tweeter on each speaker (where applicable).

- Press **▶** or **◀** to move between each of the speakers in the layout.

The display shows the speaker being tested, and the distance in feet.

For example:

Left Distance 18'0

- Press **▲** or **▼** to change the distance, in feet.
- Repeat this for each of the speakers in your layout.
- Press **▶** or **Store** to proceed to the next calibration stage.

Fine tuning

These tests allow you to fine-tune the phase and delay of each speaker when used in conjunction with other speakers on the layout.

- Press ► or ◀ to move between each of the speakers in the layout.

The first display allows you to adjust the phase.

For example:

```
Left Phase
```

The next display shows the distance (or delay) for the same speaker.

For example:

```
Left Distance 18'0
```

Choose the setting that gives an even sound between the speakers, that does not change radically as you move your head. If the setting is incorrect the sound will appear diffused, and change in timbre and apparent location as you move your head.

Pay particular attention to the centre channel, as this can have a dramatic effect on the overall sound.

As you increase the delay the speaker will appear to move away from you.

- Press ► or **Store** to proceed to the next calibration stage.

Speaker size

These tests allow you to determine the bass handling capability of large analogue speakers and subwoofers. Once set, the 861 will limit the bass level to protect the speakers from potential damage.

In each test the display shows the speaker being tested and the current size value chosen for the speaker. This value will default to zero, corresponding to maximum bass protection.

For example:

```
Left Size 15
```

- Press ► or ◀ to move between each of the speakers under test.
- Press ▲ and ▼ to adjust the Size value for the speaker.

As you increase the Size value, the test signal will get louder, since the bass protection is treating the speaker as one capable of handling more bass.

- Adjust the Size value until the speaker is just beginning to produce distortion, indicating that it is reaching its bass handling limit.

You have now completed the calibration of your system.

- Press **Off** (front panel or remote) to exit from the calibration procedure.

Setting up sources

This section explains how to use Gain/Sub mode to set up the sources connected to the digital surround controller, and configure them to suit your other equipment.

You can also adjust the subwoofer crossover frequency to suit the subwoofers in your system.

To turn on Gain/Sub mode

- Put the digital surround controller into standby by pressing **Off** (front panel or remote).
- Press and hold the **Configure** key under the front panel for at least five seconds.

The display shows:

Gain/Sub On

The digital surround controller will then return to standby with Gain/Sub mode turned on.

Gain/Sub mode adds two extra options to the DSP parameter menus: **Sensitivity** and **Xover**.

To turn off Gain/Sub mode

- Repeat the above procedure until the display shows:

Gain/Sub Off

To adjust the sensitivity of a source

To obtain the best signal-to-noise ratio for your analogue sources you can adjust the sensitivity of each input to give the highest level that does not produce clipping.

- Turn on Gain/Sub mode, as described above.
- Select the source you want to adjust, with loud source material playing.
- Press ◀ or ▶ (remote or under the front panel) until the display shows the current sensitivity.

For example:

Radio 2.0V In

- Press ▲ or ▼ (remote or under the front panel) to change the sensitivity.

You can select between sensitivities of 0.5V (most sensitive), 1.0V, 2.0V, or 2.5V (least sensitive).

If the sensitivity is set too high the input will clip the loudest passages.

The display shows, for example:

Radio 0.5V In Clip

In this case reduce the sensitivity.

If you have selected a digital source you cannot adjust the sensitivity. The display shows, for example:

CD Not Analogue

To adjust the subwoofer crossover frequency

The digital surround controller allows you to adjust the crossover frequency of any subwoofers between 30 and 150Hz. The crossover can be set independently for Music, Logic, and 5.1 Movie speaker layouts. The default is the THX standard of 80Hz. For details of which speaker layout is used by each DSP preset see *Speaker layouts*, page 5.

- Turn on Gain/Sub mode, as described above.
- Press ◀ or ▶ (remote or under the front panel) until the display shows the current crossover frequency.

For example:

Radio Xover 80Hz

- Press ▲ or ▼ (remote or under the front panel) to set the crossover frequency.

For THX loudspeaker systems you should leave the crossover setting at 80Hz.

80Hz is also the recommended setting for all movie listening. You may prefer, however, to lower the crossover frequency for music if your main speakers have good bass handling down to, say, 50Hz.

Sinewave sweep test

The 861 Reference Digital Surround Controller includes a sinewave signal test, to help you set the subwoofer crossover frequencies, or check for room resonances.

- Select a PCM source; eg an analogue source or CD.
- Press **Configure** (under the front panel).

The displays shows: 

An 80Hz sinewave will be played through all channels.





You can change the test signal using the menu keys, as described in the following sections.

To change the sweep rate

- Press ◀ or ▶ (remote or under the front panel) until the display shows:

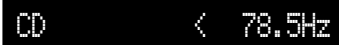

- Press ▲ or ▼ to change the sweep rate and direction, as follows:

Display	Description
	Fast sweep up.
	Slow sweep up.
	Paused.
	Slow sweep down.
	Fast sweep down.

The sine sweep will stop when it reaches 0.5Hz or 200Hz.

To change the volume

- Use the volume keys in the usual way.





Warning: Very loud low-frequency signals may damage speakers.

To select other test signals

- Press ◀ or ▶ (remote or under the front panel) until the display shows the current signal.

For example: 

- Press ▲ or ▼ to choose between the following test signals:

Display	Description
	A sinewave.
	Silence.
	The source signal in mono (left + right).
	Pink noise (band pass 500Hz to 2kHz for main channels).

To select the channel

- Press ◀ or ▶ (remote or under the front panel) until the display shows the current channels.

For example: 

- Press ▲ or ▼ to select a specific channel, or All Channels.

Index

A

Academy (DSP parameter) 31
 accessories 36
 Ambisonics (DSP preset) 28, 33
 analogue inputs 37
 analogue source, connecting 39
 analogue sources, adjusting sensitivity 51
 Axis (DSP parameter) 17
 axis, changing 20

B

back panel connections 36
 Balance (DSP parameter) 17, 20
 balanced outputs 36, 37, 38
 Bass (DSP parameter) 17, 19
 bass, changing 19
 brightness, display 14
 built-in presets, replacing 25

C

calibration procedure 48
 exiting 48
 starting 48
 calibration tests 49
 Distance 49
 Fine tuning 50
 Levels 49
 Speaker size 50
 Centre (DSP parameter) 17, 21, 28
 centre speaker
 changing the relative delay 21
 changing the relative level 21

Channels (DSP parameter) 29
 Cinema (DSP preset) 32
 clip indicator 51
 Comms, connecting 44
 communications connections 38
 Compress (DSP parameter) 34
 compression 34
 configuration 45
 resetting 46
 connecting
 to DSP loudspeakers 42, 43
 to Meridian G Series, 500 Series,
 or 800 Series equipment 44
 content types 13, 14
 Movie 2 13
 Movie 6 13
 Music 2 13
 Music 6 13
 contrast, display 14
 crossover frequency, adjusting 51

D

Depth (DSP parameter) 17, 21
 Dialog Normalisation 34
 digital inputs 38
 Digital signal processing 2
 digital source, connecting 39
 Dimension (DSP parameter) 30
 Direct (DSP preset) 30
 Discrete (DSP preset) 32
 display
 brightness 14
 contrast 14
 information 14
 Distance (calibration test) 49, 50
 DSP 2
 DSP loudspeakers
 connecting via SpeakerLink 42,
 43
 DSP parameters
 changing 17, 18
 standard 17
 DSP presets 27
 Ambisonics 28, 33
 assigning to a source 24
 changing 13
 Cinema 32
 clearing 25
 Compress parameter 34
 defining 25
 Direct 30
 Discrete 32
 editing name 25
 Mono 31
 multichannel 32
 Music 28
 PLIIx Mov6 33
 PLIIx Movie 30, 31
 PLIIx Mus6 33
 PLIIx Music 30
 PLIIx THX 30, 31
 selecting 13
 Stereo 30
 Super 29
 THX 32, 33
 THX Music 33
 THX Surround EX 33
 THX Ultra2 Cinema 33

DSP presets (*continued*)
 Trifield 28
 two-channel 28
 user-defining 25
 dynamic range control 34

F

front panel keys 8

G

Gain/Sub mode 51

H

HD621 HDMI Audio Processor 40
 HS Out? (DSP parameter) 17

I

Input (DSP parameter) 31
 inputs
 analogue 37
 digital 38
 MMHR 38
 SpeakerLink 38
 installing 35

L

layouts 5
 5.1 Movie 32
 Logic 28
 Music 28
 Levels (calibration test) 49
 LFE (DSP parameter) 32, 33
 LipSync 23

LipSync (DSP parameter) 17, 23
 listening position, changing 20
 locking the menus 16

M

menus, locking 16
 Meridian DSP loudspeakers,
 connecting to 42, 43
 Meridian System Remote keys 9
 Mix level 34
 MMHR input 38
 MMHR multichannel input 40
 Mono (DSP preset) 31
 Movie 2 13
 Movie 6 13
 multichannel digital inputs 38
 multichannel link 2
 Music (DSP preset) 28
 Music 2 13
 Music 6 13
 Music DSP presets 28
 muting the sound 12

O

outputs
 balanced 37, 38
 SpeakerLink 37
 unbalanced 37

P

Panorama (DSP parameter) 30
 Party? (DSP parameter) 31
 Phase (calibration test) 50

Phase (DSP parameter) 17, 19
 phase, changing 19
 PLLix (DSP preset) 30
 PLLix Mov6 (DSP preset) 33
 PLLix Movie (DSP preset) 31
 PLLix Mus6 (DSP preset) 33
 PLLix Music (DSP preset) 30
 PLLix THX (DSP preset) 30
 presets
 defining 25
 multichannel 32
 two-channel 28
 user-defined 25
 Pro Logic (DSP parameter) 31

R

R Delay (DSP parameter) 17, 22
 Rear (DSP parameter) 17, 20
 rear speakers
 changing the relative delay 22
 changing the relative level 20
 resetting the configuration 46
 R Filter (DSP parameter) 28, 29, 32
 Roll (DSP parameter) 29, 31
 Room Correction 3
 Row (DSP parameter) 29
 RS232 connection 38

S

SACD player, connecting to 41
 safety warnings ii
 S Delay (DSP parameter) 17, 22
 selecting a source 11

S Filter (DSP parameter) 28, 29, 32
 Sides (DSP parameter) 17, 20
 side speakers
 changing the relative delay 22
 changing the relative level 20
 sinewave sweep test 53
 Sooloos connections 38
 Sound Pressure Level meter 48
 sources 11
 adjusting sensitivity 51
 assigning DSP presets 24
 default DSP preset 13
 selecting 11
 setting up 51
 spaciousness of the sound, changing 22
 speaker layouts 5
 5.1 Movie 32
 Logic 28
 Music 28
 SpeakerLink 37, 42, 43
 connecting with 42, 43
 SpeakerLink input 38
 SpeakerLink outputs 37
 standard DSP parameters 17
 standard settings, selecting 46
 standby, switching to 10
 Steered All (DSP parameter) 29, 30
 Stereo (DSP preset) 30
 subwoofers, crossover frequency 51
 Super (DSP preset) 29
 Surr. Rear (DSP parameter) 28, 32, 33
 switching on and off 10

T

THX (DSP preset) 32, 33
 THX level 49
 THX Music (DSP preset) 33
 THX Surround EX (DSP preset) 33
 THX Ultra2 Cinema (DSP preset) 33
 time-aligning the system 49
 Treble (DSP parameter) 17, 19
 treble, changing 19
 Trifield (DSP preset) 28
 trigger outputs 38
 2+2+2 (DSP parameters) 32
 Types 46

U

UHJ format 28
 unbalanced outputs 37
 unlocking the menus 16
 unpacking 36
 user-defined presets 25
 clearing 25
 editing name 25

V

volume
 adjusting 12

W

Width (DSP parameter) 28, 29, 30

Y

Yaw (DSP parameter) 29, 31

